

# MORE INVENTIVE LESS INVASIVE

PRODUCTS  
CATALOG  
2020





MORE INVENTIVE

LESS INVASIVE



## WELCOME TO MINIMALLY INVASIVE DENTISTRY!

At ACTEON® we strive every day to create new mini-invasive technologies in surgery, in X-Ray emission, in imaging and make them available to you with an intuitive digital connectivity.

### Less is More!

- Less invasive surgery creates more trust from your patients;
- Less X-Ray is more safety for everyone in your practice;
- Less compromise in image quality leads to better information ready to be analyzed by you;
- Less complexity provides the ability to create fruitful dialogue with your patients.

We sincerely hope that our efforts will help you on this route.  
We are proud to serve you.



# IT'S TIME FOR

**ACTEON**

MINIMALLY  
INVASIVE  
SOLUTIONS

Because we believe that scientific and technical progress must have the welfare of the human being at the forefront of our mind, we base our approach on minimally invasive clinical solutions and we listen to practitioners and their patients to ensure every innovation within ACTEON® is the result of collective and respectful intelligence.

The R&D, product-marketing and production teams, in collaboration with world-leading expert-practitioners, have one common goal: an optimal quality of care. This is Our behaviour.

Our challenge. Our DNA.

# TABLE OF CONTENTS

---

## ACTEON IMAGING

---

Extraoral radiology .....	10
Intraoral radiology.....	28
Color imagery.....	52

## ACTEON EQUIPMENT

---

Surgery.....	70
Ultrasonics.....	92
Polishers.....	124
Polymerization .....	134
Miscellaneous.....	142

## ACTEON INSTRUMENTATION

---

Mirrors.....	152
Bliss.....	160
Diagnostics .....	168
Restoration .....	174
Prosthesis .....	182
Periodontics.....	188
Endodontics.....	194
Extraction.....	198
Surgery.....	210
Implantology.....	220
Orthodontics .....	234
Accessories .....	238

## ACTEON PHARMA

---

Prosthesis & Aesthetics.....	244
Endodontics.....	260
Anesthetics & Others.....	268
Hygiene .....	278

## ACTEON OEM

---

Ultrasonics.....	292
Motors.....	306
Polymerization .....	310
Intraoral cameras .....	316

## ACTEON

---

Contacts .....	326
Index.....	328
Legal Information .....	330





ACTEON  
IMAGING

IT'S TIME  
TO ADAPT  
TO THEO'S  
MORPHOLOGY



EXTRAORAL RADIOLOGY

[www.akteongroup.com](http://www.akteongroup.com)

Imaging  
YouTube Channel



Imaging catalog

**Extraoral radiology**.....

X-Mind® trium .....	12
X-Mind® trium True Low Dose .....	18
ACTEON® Imaging Suite .....	20
Accessories.....	21
X-Mind® prime 2D.....	22
X-Mind® prime 3D.....	24
X-Mind® prime Accessories .....	26



# EXTRAORAL RADIOLOGY

X-Mind® trium  
Upgradeable 3 in 1

## X MIND trium



### 3D imaging system

- Easily upgradeable
- Superior 3D image processing with sharpening and metal artefacts filters
- Patented Ceph collimation
- Large selection of F.O.V: Ø40x40, 60x60, 80x80 and 110x80



### X-MIND® TRIUM PAN



Control panel on the left\*

**W0900007**

OrthoPantoTomograph (OPG), 115-220 V, With One CMOS Pan 2D sensor for panoramic imaging

- Adult and Child Panoramic programs
- Improved Orthogonality
- TMJ section
- Maxillary Sinus exam

ACTEON® Imaging Suite Software, for visualisation and analysis of 2D acquisitions. Compatible with all 2D and 3D imaging products of the group.

Installation and user e-manuals, 2 years standard warranty.

Not included: Workstation PC and monitor, Light.

\* The control panel can be placed on the right during installation according to the practitioner's needs

Class IIb medical devices (IMQ) - CE0051  
Manufacturer: de Götzen ACTEON® Group - Italy



# EXTRAORAL RADIOLOGY

X-Mind® trium  
Upgradeable 3 in 1

### X-MIND® TRIUM PAN (CEPH READY)

Control panel on the left\*

**W0900008**

#### UPGRADES

X-Mind® trium Pan Ceph Ready Upgrade Ceph right (no sensor included)

**W0900015**

X-Mind® trium Pan Ceph Ready Upgrade Ceph left (no sensor included)

**W0900016**

### X-MIND® TRIUM PAN (3D READY)

Control panel on the left\*

**W0900226**

#### UPGRADE 3D

X-Mind® trium Pan 3D Ready Upgrade 3D

**W0900227**

#### UPGRADES CEPH

X-Mind® trium Pan 3D Ready Upgrade Ceph right (1 sensor Ceph 2D included)

**W0900018**

X-Mind® trium Pan 3D Ready Upgrade Ceph left (1 sensor Ceph 2D included)

**W0900019**

\* The control panel can be placed on the right during installation according to the practitioner's needs

### WARRANTY EXTENSIONS

Warranty extension for 1 additional year

**W0900022**

Warranty extension for 2 additional years

**W0900023**

Warranty extension for 3 additional years

**W0900024**

Class IIb medical devices (IMQ) - CE0051  
Manufacturer: de Götzen ACTEON® Group - Italy



X-Mind® trium is a class 3R laser product per IEC 60825-1:2007. Avoid direct eye exposure to laser radiation. Viewing the laser output with magnifying optical instruments (for example, surgical microscope and binocular glasses) may pose an eye hazard and thus the user should not direct the beam into an area where such instruments are likely to be used.

# EXTRAORAL RADIOLOGY

X-Mind® trium  
Upgradeable 3 in 1

## X-MIND® TRIUM PAN CEPH



CEPH right, control panel on the left\*  
CEPH left, control panel on the left\*

**W0900009**  
**W0900232**

OrthoPantoTomograph (OPG), 115-220V, with one CMOS Ceph 2D sensor used for panoramic imaging and cephalometry.

- Adult and Child Panoramic programs
- Improved Orthogonality
- TMJ section
- Maxillary Sinus exam
- Cephalometric exam

ACTEON® Imaging Suite (AIS) Software, for visualisation and analysis of 2D acquisitions. Compatible with all 2D and 3D imaging products of the group.

Installation and user e-manuals, 2 years standard warranty.  
Not included: Workstation PC and monitor, Light.

\* The control panel can be placed on the right during installation according to the practitioner's needs



## X-MIND® TRIUM PAN CEPH (3D READY)

CEPH on the right, control panel on the left\*

**W0900240**

CEPH on the left, control panel on the left\*

**W0900270**

\* The control panel can be placed on the right during installation according to the practitioner's needs

### UPGRADE 3D

X-Mind® trium Pan 3D Ready Upgrade 3D

**W0900227**

### WARRANTY EXTENSIONS

Warranty extension for 1 additional year

**W0900022**

Warranty extension for 2 additional years

**W0900023**

Warranty extension for 3 additional years

**W0900024**

# EXTRAORAL RADIOLOGY

X-Mind® trium  
Upgradeable 3 in 1

## X-MIND® TRIUM PAN 3D



Control panel on the left\*

**W0900010**

OrthoPantoTomograph (OPG), 115-220V, with one CMOS 2D sensor used for panoramic imaging and one Flat Panel Detector for CBCT.

- Adult and Child Panoramic programs
- Improved Orthogonality
- TMJ section
- Maxillary Sinus exam
- CBCT FOV Ø40x40, Ø60x60, Ø80x80, Ø110x80

Workstation PC with standard monitor.  
Software preinstalled.

ACTEON® Imaging Suite (AIS) Software, for visualisation and analysis of 2D and 3D acquisitions and treatment planning. Includes five licenses for 3D app standard, the 3D viewer and implant planning application. Compatible with all 2D and 3D imaging products of the group.

Installation and user e-manuals, 2 years standard warranty.  
Not included: Light.



### UPGRADES

X-Mind® trium Pan 3D Upgrade Ceph right (1 2D Ceph sensor included)

**W0900018**

X-Mind® trium Pan 3D Upgrade Ceph left (1 2D Ceph sensor included)

**W0900019**

### WARRANTY EXTENSIONS

Warranty extension for 1 additional year

**W0900028**

Warranty extension for 2 additional years

**W0900029**

Warranty extension for 3 additional years

**W0900030**



# EXTRAORAL RADIOLOGY

X-Mind® trium  
Upgradeable 3 in 1

## X-MIND® TRIUM PAN CEPH 3D

CEPH right, control panel on the left\*  
CEPH left, control panel on the left\*

**W0900012**  
**W0900233**



*OrthoPantoTomograph (OPG), 115-220V, with one CMOS Ceph 2D sensor used for panoramic imaging and cephalometry and one Flat Panel Detector for CBCT.*

- Adult and Child Panoramic programs
- Improved Orthogonality
- TMJ section
- Maxillary Sinus exam
- Cephalometry exam
- CBCT FOV Ø40x40, Ø60x60, Ø80x80, Ø110x80

*Workstation PC with standard monitor. Software preinstalled.*

*ACTEON® Imaging Suite (AIS) Software, for visualisation and analysis of 2D and 3D acquisitions and treatment planning. Includes five licenses for 3D app standard, the 3D viewer and implant planning application.*

*Compatible with all 2D and 3D imaging products of the group. Installation and user e-manuals, 2 years standard warranty. Not included: Light.*

*\* The control panel can be placed on the right during installation according to the practitioner's needs*

## WARRANTY EXTENSIONS

Warranty extension for 1 additional year	<b>W0900031</b>
Warranty extension for 2 additional years	<b>W0900032</b>
Warranty extension for 3 additional years	<b>W0900033</b>

For more information, please consult our website



[www.acteongroup.com/en/products/imaging](http://www.acteongroup.com/en/products/imaging)

# EXTRAORAL RADIOLOGY

X-Mind® trium  
Upgradeable 3 in 1

# EXTRAORAL RADIOLOGY

X-Mind® trium TLD  
Upgradeable 3 in 1

## X MIND trium

TRUE  
LOW DOSE



UP TO 50%  
DOSE REDUCTION

### 3D imaging system

- Easily upgradeable
- Superior 3D image processing with sharpening and metal artefacts filters
- Patented Ceph collimation
- Large selection of F.O.V: Ø40x40, 60x60, 80x90 and 110x90

### X-MIND® TRIUM TLD PAN 3D



Control panel on the left\*

**W0920010**

OrthoPantoTomograph (OPG), 115-220V, with Flat Panel Detector for CBCT and panoramic imaging.

- Child-dedicated Panoramic and CBCT programs
- Low dose CBCT programs
- Improved Orthogonality
- TMJ section
- Maxillary Sinus exam
- CBCT FOV Ø40x40, Ø60x60, Ø80x90, Ø110x90



Software preinstalled on the provided workstation and monitor.

ACTEON® Imaging Suite (AIS) Software, for visualisation and analysis of 2D and 3D acquisitions and treatment planning. Includes five licenses for 3D app PRO, the 3D viewer and implant planning application. Compatible with all 2D and 3D imaging products of the group. Installation and user e-manuals, 2 years standard warranty. Not included: Light.

\* The control panel can be placed on the right during installation according to the practitioner's needs

### WARRANTY EXTENSIONS

Warranty extension for 1 additional year	<b>W0900028</b>
Warranty extension for 2 additional years	<b>W0900029</b>
Warranty extension for 3 additional years	<b>W0900030</b>

# EXTRAORAL RADIOLOGY

X-Mind® trium TLD  
Upgradeable 3 in 1

### X-MIND® TRIUM TLD PAN 3D CEPH

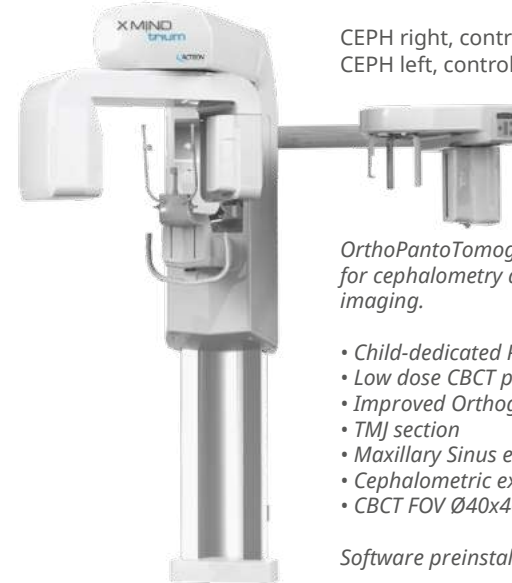

CEPH right, control panel on the left\*  
CEPH left, control panel on the left\*

**W0920012**  
**W0920233**

OrthoPantoTomograph (OPG), 115-220V, with one CMOS 2D sensor for cephalometry and a flat Panel Detector for CBCT and panoramic imaging.

- Child-dedicated Panoramic and CBCT programs
- Low dose CBCT programs
- Improved Orthogonality
- TMJ section
- Maxillary Sinus exam
- Cephalometric exams
- CBCT FOV Ø40x40, Ø60x60, Ø80x90, Ø110x90

Software preinstalled on the provided workstation and monitor.

ACTEON® Imaging Suite (AIS) Software, for visualisation and analysis of 2D and 3D acquisitions and treatment planning. Includes five licenses for 3D app PRO, the 3D viewer and implant planning application.

Compatible with all 2D and 3D imaging products of the group. Installation and user e-manuals, 2 years standard warranty. Not included: Light.

\* The control panel can be placed on the right during installation according to the practitioner's needs

### WARRANTY EXTENSIONS

Warranty extension for 1 additional year	<b>W0900031</b>
Warranty extension for 2 additional years	<b>W0900032</b>
Warranty extension for 3 additional years	<b>W0900033</b>

# EXTRAORAL RADIOLOGY

ACTEON® Imaging Suite



## ACTEON® IMAGING SUITE 4.2

AIS 3D APP STANDARD 1 dongle licence	<b>W1000007</b>
AIS 3D APP BASIC 1 electronic licence	<b>W1000012</b>
AIS 3D APP BASIC 5 electronic licences	<b>W1000013</b>
AIS 3D APP STANDARD 5 dongle licences	<b>W1000015</b>
AIS 3D APP PREMIUM 1 dongle licence	<b>W1000016</b>
AIS 3D APP PREMIUM 5 dongle licences	<b>W1000017</b>
AIS 3D APP STANDARD 1 electronic licence	<b>W1000018</b>
AIS 3D APP STANDARD 5 electronic licences	<b>W1000019</b>
AIS 3D APP PREMIUM 1 electronic licence	<b>W1000020</b>
AIS 3D APP PREMIUM 5 electronic licences	<b>W1000021</b>

## ACTEON® IMAGING SUITE 5.0

AIS 3D APP 5.0 Start	<b>W1000023</b>
AIS 3D APP 5.0 Pro	<b>W1000024</b>
AIS 3D APP 5.0 Design 1 year license, for the first year	<b>W1000025</b>
AIS 3D APP 5.0 Design 1 year license, starting the second year	<b>W1000026</b>

## ACTEON® IMAGING SUITE - DICOM LICENCE

AIS DICOM PACKAGE Licence (DICOM print licence NOT included)	<b>W0900153</b>
DICOM print licence	<b>39800751</b>

# EXTRAORAL RADIOLOGY

X-Mind® trium  
Accessories

## ACCESSORIES

<b>PAN 2D SENSOR</b> for OrthoPantoTomograph (OPG) (to add a second 2D sensor or for replacement)	<b>W0900036</b>
<b>CEPH 2D SENSOR</b> for OrthoPantoTomograph (OPG) and cephalometry (for replacement)	<b>W0900037</b>
<b>PC WORKSTATION</b> (no monitor) Windows 7, 64 bits. Nvidia Graphic card No included: network card, monitor, AIS 3D App	<b>W0900040</b>
<b>PC WORKSTATION with network card and dongle key</b> (no monitor) Windows 7, 64 bits. Nvidia Graphic card, 1 Gbit Ethernet Network card. 3D reconstruction dongle No included : monitor, AIS 3D App	<b>W0900042</b>
<b>UPGRADE KIT FOR DELL 3620 WORKSTATION</b> 1Tb SSD Hard drive 16Gb RAM P620 Nvidia GPU (display card)	<b>W0900277</b>
<b>24" MONITOR</b> Standard monitor 24"	<b>W0900141</b>
<b>REMOTE TRIGGER &amp; 15m CABLE</b>	<b>W0900091</b>
<b>EARS PROTECTIONS X-MIND® TRIUM</b> (280 pcs) only for arms Ceph	<b>W0900110</b>
<b>CHIN RESTS, BITE BLOCK, TMJ X-MIND® TRIUM</b>	<b>W0900080</b>
<b>TEMPLE BARS LEFT/RIGHT X-MIND® TRIUM</b>	<b>W0900071</b>
<b>SLIDING BITE BLOCKS X-MIND® TRIUM</b> (10 pcs)	<b>W0900142</b>
<b>BITE PROTECTIONS X-MIND® TRIUM</b> (500 pcs)	<b>W0900113</b>



**X-MIND® TRIUM SELF STANDING BASE** **W0900236**

# EXTRAORAL RADIOLOGY

X-Mind® prime 2D

X MIND  
**prime**



## X-MIND® PRIME PAN

2D Wall-mounted version 110-240V

**W1200001**

*OrthoPantoTomograph (OPG), 110V-240V, with one CCD Pan 2D sensor for panoramic imaging.*

- 24 adult and child panoramic programs
- Innovative wall-mounted system
- Face-to-face positioning
- Lightest unit on the market
- Installation under an hour by one single technician



*ACTEON® Imaging Suite Software (AIS), for visualization and analysis of 2D acquisitions. Compatible with all 2D and 3D imaging products of the group. Installation and user e-manual, 2 years standard warranty. Not included: Workstation PC and monitor, wall switch, light.*

# EXTRAORAL RADIOLOGY

X-Mind® prime 2D

## X-MIND® PRIME PAN CEPH



2D version 110-240V\*

**W1200009**

*Orthopantomograph (OPG), 110-240V with single mobile CMOS sensor for panoramic and cephalometric imaging.*

*Lightweight and compact installation  
39 adult and child acquisition programs  
Accurate and reliable patient positioning  
Fast and easy installation*

*ACTEON® Imaging Suite (AIS) Software, for visualization and analysis of 2D and 3D acquisitions and treatment planning. Includes five licenses for 3D app standard, the 3D viewer and implant planning application. Compatible with all 2D and 3D imaging products of the group. Installation and user e-manuals, 2 years standard warranty. Not included: Light.*

\* please address to your Acteon contact to check the availability of this product in your country



For more information, please consult our website



[www.acteongroup.com/en/products/imaging](http://www.acteongroup.com/en/products/imaging)



# EXTRAORAL RADIOLOGY

X-Mind® prime 3D

## X MIND prime



### X-MIND® PRIME PAN 3D

3D Wall-mounted version 110-240V  
+ WS + Monitor

**W1200005**

*OrthoPantoTomograph (OPG), 110V-240V,  
with one CMOS sensor used for Pan and 3D.*

- 54 adult and child 2D and 3D programs
- Delivered with AIS 3D app and powerful treatment planning tools
- 4 FOV : 50x50, 85x50, 85x93 and 120x100 mm
- Innovative wall-mounted system
- Face-to-face positioning
- Lightest unit on the market
- Installation under an hour by one single technician



ACTEON® Imaging Suite Software (AIS), for visualization and analysis of 2D acquisitions.  
Compatible with all 2D and 3D imaging products of the group.  
Installation and user e-manual, 2 years standard warranty.  
Included: Workstation PC and monitor.  
Not included: Wall switch, light.

# EXTRAORAL RADIOLOGY

X-Mind® prime 3D

### X-MIND® PRIME PAN 3D CEPH



3D version 110-240V\*  
+ WS + Monitor

**W1200010**

*Orthopantomograph (OPG), 110-240V equipped with a CMOS  
PAN/3D panel and a CMOS 2D CEPH sensor.*

*69 adult and child 2D PAN/CEPH and 3D programs  
Delivered with AIS 3D app and powerful treatment planning tools  
5 FOV : 50x50, 85x50, 85x93 and 120x100 mm  
Accurate and reliable patient positioning  
Fast and easy installation  
Software preinstalled.*

*ACTEON® Imaging Suite (AIS) Software, for visualization and analysis of 2D  
and 3D acquisitions and treatment planning. Includes five licenses for 3D app  
standard, the 3D viewer and implant planning application. Compatible with all  
2D and 3D imaging products of the group. Installation and user e-manuals, 2  
years standard warranty. Not included: Light.*



*\* please address to your Acteon contact the to check the availability of this product in your country*

# EXTRAORAL RADIOLOGY

X-Mind® prime 2D  
Accessories

# EXTRAORAL RADIOLOGY

## ACCESSORIES



**SELF-STANDING BASE** *W1200100*

**COLUMN** *W1200101*

**XMP 2D PC**  
Windows 10, 64 bits. Nvidia Graphic card.  
No included: network card, monitor, AIS 3D App *4695489200*

**XMP 3D WORKSTATION**  
Windows 10, 64 bits. Nvidia Graphic card, 1 Gbit  
Ethernet Network card. *6204900100*  
AIS 3D APP.  
Not included: monitor

**XMP MONITOR** *4695454900*  
Standard monitor 24"

**ETHERNET BOARD DUAL PORT** *4695488300*

**CHIN RESTS MAXILLARY SINUS** *6604011605*

**FULL 2D AND 3D PANORAMIC CHIN REST** *6604012000*

**CHIN REST FOR EDENTULOUS** *5407098100*

**TMJ SUPPORT** *6604011800*

**TEMPLE BAR RIGHT & LEFT 2D 3D & CEPH** *6604010312*

**PAN CENTERING BITES x50** *6607090100*

**DISPOSABLE BITE PROTECTIVE SLEEVES**  
x100 *6107110700*





# INTRAORAL RADIOLOGY

[www.acteongroup.com](http://www.acteongroup.com)

Imaging  
YouTube Channel



Imaging catalog

**Intraoral radiology .....**

X-Mind® unity .....	30
X-Mind® DC.....	34
PSPiX <sup>2</sup> ® .....	38
U-Scan.....	44
SOPIX® / SOPIX <sup>2</sup> ® .....	46
SOPIX® Inside / SOPIX <sup>2</sup> ® Inside.....	48
U-Sense HD / U-Sense.....	50



# INTRAORAL RADIOLOGY

X-Mind® unity

## X MIND unity

- 0.4 mm focal spot
- Configurable radiological settings (time, mA, kV)
- Ace – Reducing patient dose by up to 50%
- Dosage display
- Top and bottom mounting

X-Mind® unity is pre-wired for the integration of the SopiX® inside / SOPIX®<sup>2</sup> inside digital sensor. Delivered with a long cone in standard version.



### X-MIND® UNITY - MOBILE



Package including mobile support and X-Mind® unity for mobile support

- 1- Mobile support for X-Mind® unity **W0800127**
- 2- X-Mind® unity for mobile support:
  - Mobile support - Long cone **W0800085**
  - Mobile support - Short cone **W0800091**
  - Mobile support - Long square cone **W0800128**
  - Mobile support - Short square cone **W0800129**



# INTRAORAL RADIOLOGY

X-Mind® unity

## X-MIND® UNITY - TOP MOUNTING

### SHORT CONE

- Extensor 0.40m
- Extensor 0.80m
- Extensor 1.10m

- W0800000**
- W0800001**
- W0800002**

### LONG CONE

- Extensor 0.40m
- Extensor 0.80m
- Extensor 1.10m

- W0800003**
- W0800004**
- W0800005**

### SHORT SQUARE CONE

- Extensor 0.40m
- Extensor 0.80m
- Extensor 1.10m

- W0800102**
- W0800103**
- W0800104**

### LONG SQUARE CONE

- Extensor 0.40m
- Extensor 0.80m
- Extensor 1.10m

- W0800006**
- W0800007**
- W0800008**

## X-MIND® UNITY - BOTTOM MOUNTING

### SHORT CONE

- Extensor 0.40m
- Extensor 0.80m
- Extensor 1.10m

- W0800009**
- W0800010**
- W0800011**

### LONG CONE

- Extensor 0.40m
- Extensor 0.80m
- Extensor 1.10m

- W0800012**
- W0800013**
- W0800014**

### SHORT SQUARE CONE

- Extensor 0.40m
- Extensor 0.80m
- Extensor 1.10m

- W0800105**
- W0800106**
- W0800107**

### LONG SQUARE CONE

- Extensor 0.40m
- Extensor 0.80m
- Extensor 1.10m

- W0800015**
- W0800016**
- W0800017**



# INTRAORAL RADIOLOGY

X-Mind® unity  
Accessories

## X-MIND® UNITY ACCESSORIES



X-MIND® UNITY SHORT CONE

W0800018



X-MIND® UNITY LONG CONE

W0800019



X-MIND® UNITY SHORT SQUARE CONE

W0800137



X-MIND® UNITY LONG SQUARE CONE

W0800020



X-MIND® UNITY TUBEHEAD

W0800022



X-MIND® UNITY TIMER

W0800023



IRIX 70 WALL PLATE  
for X-Mind® unity installation

W0800100

# INTRAORAL RADIOLOGY

X-Mind® unity  
Accessories

**EXTENSOR 0.40m** X-Mind® unity top mounting

W0800025

**EXTENSOR 0.80m** X-Mind® unity top mounting

W0800026

**EXTENSOR 1.10m** X-Mind® unity top mounting

W0800027

**EXTENSOR 0.40m** X-Mind® unity bottom mounting

W0800028

**EXTENSOR 0.80m** X-Mind® unity bottom mounting

W0800029

**EXTENSOR 1.10m** X-Mind® unity bottom mounting

W0800030

**EXTENSOR pantograph** X-Mind® unity

W0800031

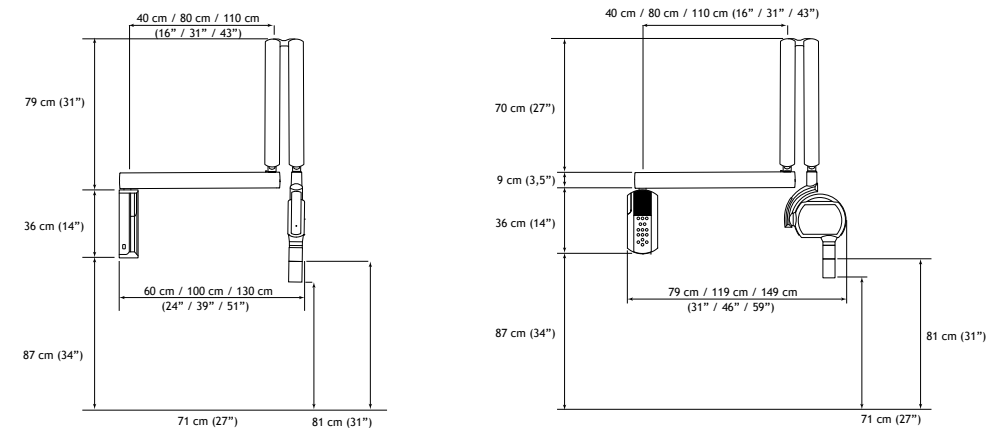
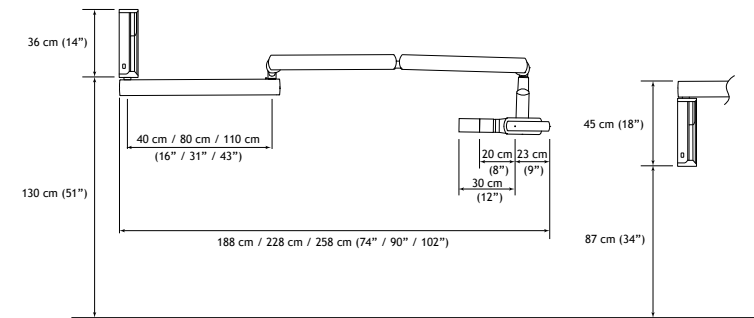

# INTRAORAL RADIOLOGY

X-Mind® DC

## X MIND DC

Delivered with a generator 70KV, a pantograph, an extensor and a timer.



### X-MIND® DC - TOP MOUNTING

<b>EXTENSOR 0.40m</b>	(max. distance 143cm)	Long cone	<b>5.92.23137</b>
<b>EXTENSOR 0.40m</b>	(max. distance 143cm)	Square cone	<b>5.92.23167</b>
<b>EXTENSOR 0.80m</b>	(max. distance 184cm)	Long cone	<b>5.92.23138</b>
<b>EXTENSOR 0.80m</b>	(max. distance 184cm)	Square cone	<b>5.92.23168</b>
<b>EXTENSOR 1.10m</b>	(max. distance 212cm)	Long cone	<b>5.92.23139</b>
<b>EXTENSOR 1.10m</b>	(max. distance 212cm)	Square cone	<b>5.92.23169</b>

### X-MIND® DC - BOTTOM MOUNTING

<b>EXTENSOR 0.40m</b>	(max. distance 143cm)	Long cone	<b>5.92.23130</b>
<b>EXTENSOR 0.40m</b>	(max. distance 143cm)	Square cone	<b>5.92.23160</b>
<b>EXTENSOR 0.80m</b>	(max. distance 184cm)	Long cone	<b>5.92.23131</b>
<b>EXTENSOR 0.80m</b>	(max. distance 184cm)	Square cone	<b>5.92.23161</b>
<b>EXTENSOR 1.10m</b>	(max. distance 212cm)	Long cone	<b>5.92.23132</b>
<b>EXTENSOR 1.10m</b>	(max. distance 212cm)	Square cone	<b>5.92.23162</b>

### X-MIND® DC - UNIT

<b>MOUNTING EXTENSOR 0.40m</b>	Long cone	<b>5.92.23135</b>
--------------------------------	-----------	-------------------

### X-MIND® DC - CEILING

<b>CEILING MOUNTING EXTENSOR 0.40m</b>	Long cone	<b>5.92.23136</b>
--	-----------	-------------------

(standard Faro column Ø60cm) *Ceiling fasteners not included*

### X-MIND® DC - MOBILE

<b>WITH MOBILE SUPPORT</b>	Long cone	<b>5.92.23133</b>
<b>WITH MOBILE SUPPORT</b>	Square cone	<b>5.92.23163</b>



Class IIb medical devices (IMQ) - CE0051  
Manufacturer: de Götzen ACTEON® Group - Italy

# INTRAORAL RADIOLOGY

X-Mind® DC  
Accessories

## X-MIND® DC ACCESSORIES



**X-MIND® AC TUBEHEAD** **5.21.23130**



**X-MIND® DC TUBEHEAD** **5.31.23130**



**X-MIND® AC TIMER** **5.25.23130**



**X-MIND® DC TIMER** **5.35.23130**



**SHORT CONE (20cm SSD)** **29701195**



**LONG CONE (31cm SSD)** **29701197**



**SQUARE CONE (31cm SSD)** **29701199.C**



**X-MIND® AC/DC WALL PLATE**  
bottom mounting **29700384.C**



**X-MIND® AC/DC WALL PLATE**  
top mounting **29700385.C**

**IRIX 70 WALL PLATE**  
for X-Mind® AC or DC installation **22002350**

# INTRAORAL RADIOLOGY

X-Mind® DC  
Accessories

# INTRAORAL RADIOLOGY

X-Mind® DC  
Mounting



**X-MIND® AC PANTOGRAPH**

**29700813.C**



**X-MIND® DC PANTOGRAPH**

**29701006.C**



**X-MIND® AC/DC 0.40m EXTENSOR**  
bottom mounting

**29700380.C**

**X-MIND® AC/DC 0.80m EXTENSOR**  
bottom mounting

**29700378.C**

**X-MIND® AC/DC 1.10m EXTENSOR**  
bottom mounting

**29700379.C**



**X-MIND® AC/DC 0.80m EXTENSOR**  
with pantograph and wall plate

**5.30.00131**

**X-MIND® AC/DC 1.10m EXTENSOR**  
with pantograph and wall plate

**5.30.00132**



**X-MIND® AC/DC 0.40m EXTENSOR**  
top mounting

**29700620.C**

**X-MIND® AC/DC 0.80m EXTENSOR**  
top mounting

**29700621.C**

**X-MIND® AC/DC 1.10m EXTENSOR**  
top mounting

**29700622.C**

**X-MIND® AC/DC 0.40m EXTENSOR**  
column unit

**29700381.C**

**X-MIND® AC/DC 0.40m EXTENSOR**  
ceiling mounting

**29700382.C**

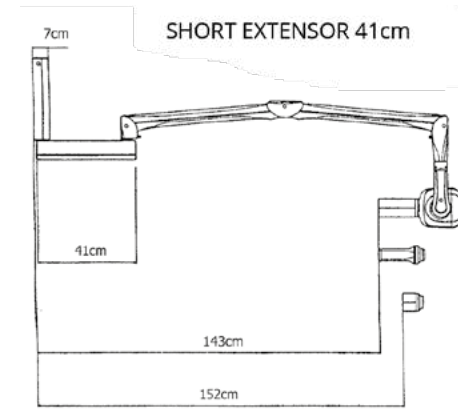

**BRACKET 0.41m**

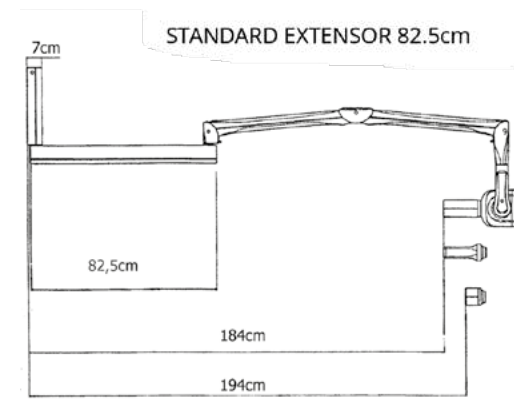

**BRACKET 0.825m**

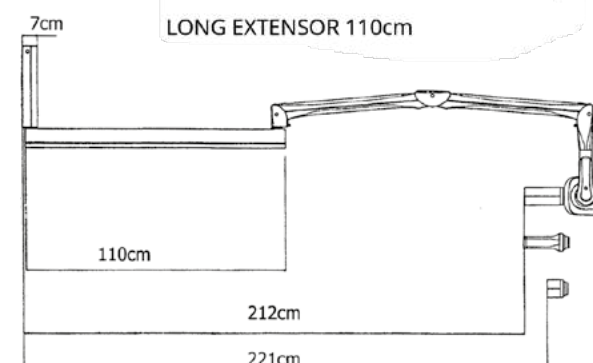

**BRACKET 1.10m**

# INTRAORAL RADIOLOGY

PSPiX®2

# PSPiX<sup>2</sup>



## PSPiX®2

Digital imaging plate system

S\_702\_0013

Includes 4 imaging plates (2x size 1, 2x size 2), 200 bags & covers for imaging plate (100x size 1, 100x size 2), an imaging plate storage box, 1 stylus for touchscreen, 10 samples of Soprowipes, 1 power supply 100-240 VAC, 1 Ethernet cable, SOPRO Imaging software and its licence.

*Class I medical device - CE - Manufacturer: Sopro - France*



	WINDOWS® MINIMUM CONFIGURATION REQUIRED	MAC® MINIMUM CONFIGURATION REQUIRED
<b>Processor</b>	Intel i5	Quadcore 2.6 GHz
<b>Hard disk</b>	300 GB	300 GB
<b>RAM</b>	4 GB	4 GB
<b>Graphic card</b>	Compatible OPEN GL 2.1 (suggested an NVIDIA GT/GTX)	Compatible OPEN GL 2.1 (suggested an NVIDIA GT/GTX)
<b>Screen resolution</b>	1600 x 1024	1600 x 1024
<b>Network card</b>	100 Mb	100 Mb
<b>Operation system</b>	Windows 7 64 bits	OS X Sierra (10.12)

# INTRAORAL RADIOLOGY

PSPiX®2  
Accessories

## STANDARD IMAGING PLATE

	PSPiX®2		PSPiX® 1 <sup>st</sup> generation	
	Set of 2		Set of 6	
Size 0 (22 x 35mm)		990215		S_700178
Size 1 (24 x 40mm)		990216		S_700179
Size 2 (31 x 41mm)		990217		S_700180
Size 3 (27 x 54mm)		990218		S_700181

## IDOT™ IMAGING PLATE

Numbered plate for better identification  
Only for PSPiX 1<sup>st</sup> generation

	PSPiX® 1 <sup>st</sup> generation	
	Set of 6	
Size 0 (22 x 35mm)		S_700182
Size 1 (24 x 40mm)		S_700183
Size 2 (31 x 41mm)		S_700184
Size 3 (27 x 54mm)		S_700185



# INTRAORAL RADIOLOGY

PSPIX®<sup>2</sup>  
Accessories

## PROTECTIVE BAG FOR IMAGING PLATE

		PSPIX® <sup>2</sup> & PSPIX® (1 <sup>st</sup> generation)
		Set of 250
Size 0		<b>700342L</b>
Size 1		<b>700343L</b>
Size 2		<b>700344L</b>
Size 3		<b>700345L</b>

## BAG & COVER FOR IMAGING PLATE with integrated cardboard envelop

	PSPIX® <sup>2</sup>		PSPIX® 1 <sup>st</sup> generation	
	Set of 300		Set of 250	
Size 0		<b>700546</b>		<b>700338L</b>
Size 1		<b>700547</b>		<b>700339L</b>
Size 2		<b>700548</b>		<b>700340L</b>
Size 3		<b>700549</b>		<b>700341L</b>

PSPIX®<sup>2</sup>  
Accessories

## PSPIX®<sup>2</sup> ACCESSORIES



**BAG & COVER for imaging plate start up kit**  
(set of 100 pieces of size 1 and 100 pieces of size 2)

**700550**



**IMAGING PLATE STORAGE BOX**  
(delivered without imaging plates)

**990219**



**STYLUS FOR PSPIX®<sup>2</sup> TOUCHSCREEN**

**005132**

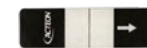

**CLEANING PLATE for PSPIX®<sup>2</sup>**

**990243**



**UNIT COVER for PSPIX®<sup>2</sup>**

**990247**



**AUTOCLAVABLE REMOVABLE PARTS for PSPIX®<sup>2</sup>**

Contains 1 removable autoclavable receptacle and 1 autoclavable insertion guide for imaging plates

**990241**



**SIZE 4 KIT for PSPIX®<sup>2</sup>**

Delivered with 1 positioning holder (size 4), 3 imaging plates (size 3) and 100 Hygiene Bag (size 4)

**990252**

**PLASTIC HOLDER size 4**

**990251**

**IMAGING PLATES size 3**  
(Set of 3)

**990248**

**PROTECTIVE BAG size 4**  
(Set of 100)

**700644**

# INTRAORAL RADIOLOGY

PSPIX<sup>2</sup>  
Accessories

## PSPIX® 1<sup>st</sup> GENERATION - ACCESSORIES



### STARTER KIT OF STANDARD IMAGING PLATE

Includes 10 standard imaging plate of four different sizes (2x size 0, 2x size 1, 5x size 2 et 1x size 3)

S\_700200

*ERLM PSPIX: Class IIa medical devices (Eurofins) - CE 0537  
Manufacturer: Soredex - Distributor: Sopro - France*



### STARTER KIT OF ACCESSORIES

100 Hygiene Bag and 100 Protective Cover of each size

S\_700201



### IMAGING PLATE STORAGE BOX (delivered without imaging plates)

S\_700482



### «MEDICAL DEVICE» POWER SUPPLY for PSPIX®

703004

## ACCESSORIES

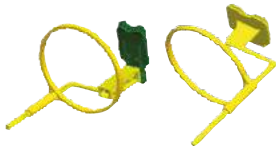

### POSITIONING SET FOR PSPIX® IMAGING PLATE

Includes five positioning holders with ring for bitewing and one centring devices

S\_700195



### POSITIONING SET FOR PSPIX® IMAGING PLATE

Includes two positioning holders with ring for anterior teeth, two positioning holders with ring for posterior teeth and two centring devices

S\_700196

*Class I medical device - CE - Manufacturer: KerrHawe SA  
Distributor: Sopro - France*



### SOPROTABS

Adhesive foam tab (500 pieces in a single pasteboard)

700406

*Discontinued, available until stock runs out  
Class I medical device - CE - Manufacturer: Sopro - France*

# INTRAORAL RADIOLOGY

PSPIX<sup>2</sup>  
Accessories



ACTEON

INNOVATIVE  
IMAGING



# INTRAORAL RADIOLOGY

U-SCAN

# U-SCAN



U-SCAN USB\*

**W1400001**

U-SCAN ETHERNET\*

**W1400002**

Includes: Includes 4 imaging plates (2x size 0, 2x size 2), 100 bags for imaging plate (50x size 0, 50x size 2), 20 covers for imaging plate (10x size 0, 10x size 2), 1 power supply 100-240 VAC, 1 Schuko plug, 1 UK plug, 1 USB flash drive with software and user guides.

*Class IIa medical device - CE - Manufacturer: de Götzen - Italy*



	<b>WINDOWS® MINIMUM CONFIGURATION REQUIRED</b>	<b>MAC® MINIMUM CONFIGURATION REQUIRED</b>
<b>Processor</b>	Intel i5	Quadcore 2.6 GHz
<b>Hard disk</b>	300 GB	300 GB
<b>RAM</b>	4 GB	4 GB
<b>Graphic card</b>	Compatible OPEN GL 2.1 (suggested an NVIDIA GT/GTX)	Compatible OPEN GL 2.1 (suggested an NVIDIA GT/GTX)
<b>Screen resolution</b>	1600 x 1024	1600 x 1024
<b>Network card</b>	100 Mb	100 Mb
<b>Operation system</b>	Windows 7 64 bits	OS X Sierra (10.12)

# INTRAORAL RADIOLOGY

U-SCAN  
Accessories

## U-SCAN ACCESSORIES



### U-SCAN REFILL KIT SIZE 0

4 plates size 0  
20 paper protections size 0 (in 2x10 units bags)

**W1400100**

### U-SCAN REFILL KIT SIZE 1

4 plates size 1  
20 paper protections size 1 (in 2x10 units bags)

**W1400101**

### U-SCAN REFILL KIT SIZE 2

4 plates size 2  
20 paper protections size 2 (in 2x10 units bags)

**W1400102**

### U-SCAN REFILL KIT SIZE 3

4 plates size 3  
20 paper protections size 3 (in 2x10 units bags)

**W1400103**

### SCAN PROTECTION SLEEVES SIZE 0 (Box of 300)

**W1400104**

### SCAN PROTECTION SLEEVES SIZE 1 (Box of 300)

**W1400105**

### SCAN PROTECTION SLEEVES SIZE 2 (Box of 300)

**W1400106**

### SCAN PROTECTION SLEEVES SIZE 3 (Box of 300)

**W1400107**

### SCAN POWER SUPPLY SCANNER (No plug cable)

**W1400110**

### SCAN PAPER COVERS SIZE 0 (Pack of 100)

**W1400114**

### SCAN PAPER COVERS SIZE 1 (Pack of 100)

**W1400115**

### SCAN PAPER COVERS SIZE 2 (Pack of 100)

**W1400116**

### SCAN PAPER COVERS SIZE 3 (Pack of 100)

**W1400117**

# INTRAORAL RADIOLOGY

Sopix / Sopix<sup>2</sup>

## SOPIX<sup>2</sup>



CMOS sensor with optic fiber of 1.5 million of pixels (size 1) or 2.21 millions of pixels (size 2), theoretical resolution of 25pl/mm, actual resolution > 18pl/mm, 3.70m cable. Includes ACE technology (Automatic Control Exposure). Delivered with a sensor holder, 10 sensor sheaths, the ACTEON® Imaging Suite (AIS) software.

**SOPIX<sup>2</sup> USB SENSOR SIZE 1**  
HIGH DEFINITION **S\_802\_0008**

**SOPIX<sup>2</sup> USB SENSOR SIZE 2**  
HIGH DEFINITION **S\_802\_0009**



## SOPIX



CMOS sensor with optic fiber of 1.5 million of pixels (size 1) or 2.21 millions of pixels (size 2), theoretical resolution of 25pl/mm, actual resolution > 12pl/mm, 3.70m cable. Includes ACE technology (Automatic Control Exposure). Delivered with a sensor holder, 10 sensor sheaths, the ACTEON® Imaging Suite (AIS) software.

**SOPIX® USB SENSOR SIZE 1**  
STANDARD DEFINITION **S\_802\_3008**

**SOPIX® USB SENSOR SIZE 2**  
STANDARD DEFINITION **S\_802\_3009**



# INTRAORAL RADIOLOGY

Sopix / Sopix<sup>2</sup>  
Accessories

	WINDOWS® MINIMUM CONFIGURATION REQUIRED	MAC® MINIMUM CONFIGURATION REQUIRED
<b>Processor</b>	Intel i5	Quadcore 2.6 GHz
<b>Hard disk</b>	300 GB	300 GB
<b>RAM</b>	4 GB	4 GB
<b>Graphic card</b>	Compatible OPEN GL 2.1 (suggested an NVIDIA GT/GTX)	Compatible OPEN GL 2.1 (suggested an NVIDIA GT/GTX)
<b>Screen resolution</b>	1600 x 1024	1600 x 1024
<b>Network card</b>	100 Mb	100 Mb
<b>Operation system</b>	Windows 7 64 bits	OS X Sierra (10.12)

## SOPIX<sup>2</sup>/SOPIX® ACCESSORIES



**POSITIONING SET for Sopix<sup>2</sup>/Sopix® series sensors**  
Includes five positioning holders with ring (bitewing, anterior, posterior, endo anterior, endo posterior) **700042**



**SOPIX<sup>2</sup>/SOPIX® SENSOR HOLDER**  
Size 1 or Size 2 **926039**



**SHEATHS for Sopix<sup>2</sup>/Sopix®**  
(500 pieces in a single pasteboard)  
for size 1 SOPIX<sup>2</sup> series sensors **403026**  
for size 2 SOPIX<sup>2</sup> series sensors **403027**



**USB 2.0 ACTIVE REPETER CABLE (Booster)**  
Length: 5m **700381**



**SOPROTABS**  
Adhesive foam tab (500 pieces in a single pasteboard)  
*Discontinued, available until stock runs out* **700406**

## ACTEON® IMAGING SUITE (AIS) SOFTWARE



**ACTEON® IMAGING SUITE (AIS) DVD** **990263**

# INTRAORAL RADIOLOGY

Sopix<sup>2</sup> Inside

# INTRAORAL RADIOLOGY

Sopix Inside



### Digital X-ray Systems to integrate into X-Mind<sup>®</sup> unity

CMOS sensor with optic fiber of 1.5 million of pixels (size 1) or 2.21 millions of pixels (size 2), theoretical resolution of 25pl/mm, actual resolution > 18pl/mm, 0.70m cable. Includes ACE technology (Automatic Control Exposure).

Delivered with a sensor holder, 10 sensor sheaths, the ACTEON<sup>®</sup> Imaging Suite (AIS) software and its licence.

**SOPIX<sup>®2</sup> INSIDE SENSOR SIZE 1**  
HIGH DEFINITION

**S\_802\_5010**

**SOPIX<sup>®2</sup> INSIDE SENSOR SIZE 2**  
HIGH DEFINITION

**S\_802\_5011**

### Digital X-ray Systems to integrate into X-Mind<sup>®</sup> unity

CMOS sensor with optic fiber of 1.5 million of pixels (size 1) or 2.21 millions of pixels (size 2), theoretical resolution of 25 pl/mm, actual resolution > 12 pl/mm, 3.70m cable. Includes ACE technology (Automatic Control Exposure).

Delivered with a sensor holder, 10 sensor sheaths, the ACTEON<sup>®</sup> Imaging Suite (AIS) software and its licence.

**SOPIX<sup>®</sup> INSIDE SENSOR SIZE 1**  
STANDARD DEFINITION

**S\_802\_6010**

**SOPIX<sup>®</sup> INSIDE SENSOR SIZE 2**  
STANDARD DEFINITION

**S\_802\_6011**





# INTRAORAL RADIOLOGY

U-Sense HD / U-Sense

## U·SENSE<sup>HD</sup>



CMOS sensor with optic fiber of 1.5 million of pixels (size 1) or 2.21 millions of pixels (size 2), theoretical resolution of 25pl/mm, actual resolution > 18pl/mm, 3.0 m USB cable. Delivered with a sensor holder, 20 sensor sheaths, the ACTEON® Imaging Suite (AIS) software.

**U-SENSE HD SIZE 1\*** **W1300003**

**U-SENSE HD SIZE 2\*** **W1300004**



## U·SENSE



CMOS sensor with optic fiber of 1.5 million of pixels (size 1) or 2.21 millions of pixels (size 2), theoretical resolution of 25pl/mm, actual resolution > 14pl/mm, 3.0 m USB cable. Delivered with a sensor holder, 20 sensor sheaths, the ACTEON® Imaging Suite (AIS) software.

**U-SENSE SIZE 1\*** **W1300001**

**U-SENSE SIZE 2\*** **W1300002**



\*please address to your ACTEON® contact the to check the availability of this product in your country  
Class IIa Medical devices (GMED) - CE0459 - Manufacturer: Sopro - France -

# INTRAORAL RADIOLOGY

U-Sense HD / U-Sense Accessories

	WINDOWS® MINIMUM CONFIGURATION REQUIRED	MAC® MINIMUM CONFIGURATION REQUIRED
<b>Processor</b>	Intel i5	Quadcore 2.6 GHz
<b>Hard disk</b>	300 GB	300 GB
<b>RAM</b>	4 GB	4 GB
<b>Graphic card</b>	Compatible OPEN GL 2.1 (suggested an NVIDIA GT/GTX)	Compatible OPEN GL 2.1 (suggested an NVIDIA GT/GTX)
<b>Screen resolution</b>	1600 x 1024	1600 x 1024
<b>Network card</b>	100 Mb	100 Mb
<b>Operation system</b>	Windows 7 64 bits	OS X Sierra (10.12)

## U-SENSE HD / U-SENSE ACCESSORIES

**SENSOR 500 COVER SIZE 1** **W1300100**

**SENSOR 500 COVER SIZE 2** **W1300101**

**SENSOR KIT POSITIONER SIZE 1** **W1300102**

**SENSOR KIT POSITIONER SIZE 2** **W1300103**

## ACTEON® IMAGING SUITE (AIS) SOFTWARE



**ACTEON® IMAGING SUITE (AIS) DVD** **990263**

For more information, please consult our website



[www.acteongroup.com/en/products/imaging](http://www.acteongroup.com/en/products/imaging)



## COLOR IMAGERY

[www.acteongroup.com](http://www.acteongroup.com)

Imaging  
YouTube Channel



Imaging catalog

<b>Color imagery</b> .....	
Soprocure® .....	54
Soprolife® .....	56
Sopro® 717 First.....	58
Sopro® 617 .....	60
Docking Stations .....	62
Accessories.....	64
Cables .....	65
Connections.....	66



# COLOR IMAGERY

Diagnostic Tools

## SOPROCARE



### SOPROCARE® HANDPIECE

S\_950\_0008

Delivered with four SOPROTIPS, a handpiece holder, ACTEON® Imaging Suite (AIS) software and its licence.  
Needs to be used with a docking station.

*Class I medical device - CE - Manufacturer: Sopro - France*



	WINDOWS® MINIMUM CONFIGURATION REQUIRED	MAC® MINIMUM CONFIGURATION REQUIRED
<b>Processor</b>	Intel i5	Quadcore 2.6 GHz
<b>Hard disk</b>	300 GB	300 GB
<b>RAM</b>	4 GB	4 GB
<b>Graphic card</b>	Compatible OPEN GL 2.1 (suggested an NVIDIA GT/GTX)	Compatible OPEN GL 2.1 (suggested an NVIDIA GT/GTX)
<b>Screen resolution</b>	1600 x 1024	1600 x 1024
<b>Network card</b>	100 Mb	100 Mb
<b>Operation system</b>	Windows 7 64 bits	OS X Sierra (10.12)

# COLOR IMAGERY

Diagnostic Tools

## PACKS SOPROCARE® + DOCK



SOPROCARE® + MINI DOCK USB2

S\_950\_0008  
+  
S\_717\_1602



SOPROCARE® + MINI DOCK U USB2<sup>(1)</sup>

S\_950\_0008  
+  
MINI DOCK  
U\_USB2

*(1) Mini Dock U USB2 : Built-in docking station with USB2 output.*

*Class I medical devices - CE - Manufacturer: Sopro - France*



PERIO Mode



CARIO Mode



DAYLIGHT Mode

For more information, please consult our website



[www.acteongroup.com/en/products/imaging](http://www.acteongroup.com/en/products/imaging)

# COLOR IMAGERY

Diagnostic Tools

## SOPROLIFE



### SOPROLIFE® HANDPIECE

S\_900\_0008

Delivered with four SOPROTIPS, a SOPROLIFE® handpiece holder, ACTEON® Imaging Suite (AIS) software and its licence.  
Needs to be used with a docking station.

*Class I medical device - CE - Manufacturer: Sopro - France*



	WINDOWS® MINIMUM CONFIGURATION REQUIRED	MAC® MINIMUM CONFIGURATION REQUIRED
Processor	Intel i5	Quadcore 2.6 GHz
Hard disk	300 GB	300 GB
RAM	4 GB	4 GB
Graphic card	Compatible OPEN GL 2.1 (suggested an NVIDIA GT/GTX)	Compatible OPEN GL 2.1 (suggested an NVIDIA GT/GTX)
Screen resolution	1600 x 1024	1600 x 1024
Network card	100 Mb	100 Mb
Operation system	Windows 7 64 bits	OS X Sierra (10.12)

# COLOR IMAGERY

Diagnostic Tools

## PACKS SOPROCARE® + DOCK



SOPROLIFE® + MINI DOCK USB2

S\_900\_0008  
+  
S\_717\_1602



SOPROLIFE® + MINI DOCK U USB2<sup>(1)</sup>

S\_900\_0008  
+  
MINI DOCK  
U\_USB2

*(1) Mini Dock U USB2 : Built-in docking station with USB2 output.*

*Class I medical devices - CE - Manufacturer: Sopro - France*

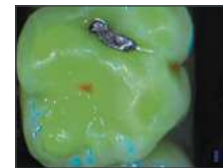

DIAGNOSTIC Mode



TREATMENT Mode



DAYLIGHT Mode

For more information, please consult our website



[www.acteongroup.com/en/products/imaging](http://www.acteongroup.com/en/products/imaging)

# COLOR IMAGERY

Intraoral Cameras

## SOPRO<sup>®</sup> 717 FIRST



### SOPRO<sup>®</sup> 717 FIRST HANDPIECE

**S\_717\_0105**

Delivered with a SOPRO<sup>®</sup> 717 First handpiece holder, ACTEON<sup>®</sup> Imaging Suite (AIS) software and its licence.  
Needs to be used with a docking station.

*Class I medical device - CE - Manufacturer: Sopro - France*



	WINDOWS <sup>®</sup> MINIMUM CONFIGURATION REQUIRED	MAC <sup>®</sup> MINIMUM CONFIGURATION REQUIRED
<b>Processor</b>	Intel i5	Quadcore 2.6 GHz
<b>Hard disk</b>	300 GB	300 GB
<b>RAM</b>	4 GB	4 GB
<b>Graphic card</b>	Compatible OPEN GL 2.1 (suggested an NVIDIA GT/GTX)	Compatible OPEN GL 2.1 (suggested an NVIDIA GT/GTX)
<b>Screen resolution</b>	1600 x 1024	1600 x 1024
<b>Network card</b>	100 Mb	100 Mb
<b>Operation system</b>	Windows 7 64 bits	OS X Sierra (10.12)

# COLOR IMAGERY

Intraoral Cameras

## PACKS SOPROCARE<sup>®</sup> + DOCK



SOPRO<sup>®</sup> 717 FIRST + MINI DOCK USB2

**S\_717\_0105**  
+  
**S\_717\_1602**



SOPRO<sup>®</sup> 717 FIRST + MINI DOCK U USB2<sup>(1)</sup>

**S\_717\_0105**  
+  
**MINI DOCK U\_USB2**

*(1) Mini Dock U USB2 : Built-in docking station with USB2 output.*

*Class I medical devices - CE - Manufacturer: Sopro - France*

# MACROVISION

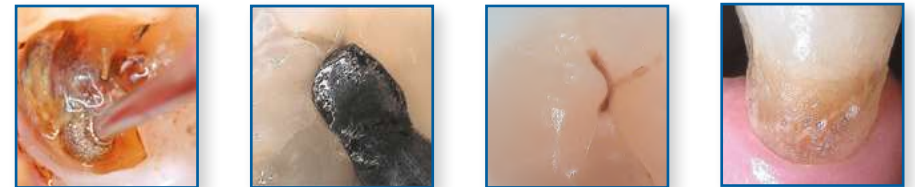

For more information, please consult our website



[www.acteongroup.com/en/products/imaging](http://www.acteongroup.com/en/products/imaging)



# COLOR IMAGERY

Intraoral Cameras

## SOPRO 617



### SOPRO® 617 HANDPIECE

S\_617\_0031

Delivered with a SOPRO® 617 handpiece holder, ACTEON® Imaging Suite (AIS) software and its licence.  
Needs to be used with a docking station

*Class I medical device - CE - Manufacturer: Sopro - France*



	WINDOWS® MINIMUM CONFIGURATION REQUIRED	MAC® MINIMUM CONFIGURATION REQUIRED
<b>Processor</b>	Intel i5	Quadcore 2.6 GHz
<b>Hard disk</b>	300 GB	300 GB
<b>RAM</b>	4 GB	4 GB
<b>Graphic card</b>	Compatible OPEN GL 2.1 (suggested an NVIDIA GT/GTX)	Compatible OPEN GL 2.1 (suggested an NVIDIA GT/GTX)
<b>Screen resolution</b>	1600 x 1024	1600 x 1024
<b>Network card</b>	100 Mb	100 Mb
<b>Operation system</b>	Windows 7 64 bits	OS X Sierra (10.12)

# COLOR IMAGERY

Intraoral Cameras

## PACKS SOPROCARE® + DOCK



SOPRO® 617 FIRST + MINI DOCK USB2

S\_617\_0031  
+  
S\_717\_1602



SOPRO® 617 FIRST + MINI DOCK U USB2<sup>(1)</sup>

S\_617\_0031  
+  
MINI DOCK  
U\_USB2

*(1) Mini Dock U USB2 : Built-in docking station with USB2 output.*

*Class I medical devices - CE - Manufacturer: Sopro - France*



# COLOR IMAGERY

## Docking Stations

### DOCKING STATIONS



#### MINI DOCK USB2

Docking station USB2.0 Including one 2.5 meters linking cable and one 0.8 meter repeater cable

S\_717\_1602



#### MINI DOCK U USB2

Built-in docking station with USB2 output  
Please select the accessories for this module on page 52.

MINI DOCK  
U\_USB2

Class I medical devices - CE - Manufacturer: Sopro - France

# COLOR IMAGERY

## Docking Stations

### CONFIGURATION OF DOCKS U

#### BUILT-IN DOCKING STATION



Mini dock U USB2

#### SHEATH



#### HOLDER



#### LINKING CABLE



#### ACCESSORIES



USB2.0 cable  
5m

#### FOOTSWITCH OPTION



# COLOR IMAGERY

Cameras  
Accessories

## ACTEON® IMAGING SUITE (AIS) SOFTWARE



ACTEON® IMAGING SUITE (AIS) DVD

990263

## FOOTSWITCHES



FOOTSWITCH FOR IMAGE MEMORY

009002



USB2 FOOTSWITCH FOR IMAGE MEMORY

009009

## SHEATHS



**SHEATHS for SOPROLIFE®, SOPROCARE® or SOPRO® 717 First**  
500 pieces in a single pasteboard

403017

**SHEATHS for SOPRO® 617**  
500 pieces in a single pasteboard

403023

**SHEATHS for SOPRO® 595**  
500 pieces in a single pasteboard

403001

## HANDPIECE HOLDER



**HANDPIECE HOLDER for SOPROLIFE®, SOPROCARE®, Sopro® 717 First, SOPRO® 617 and SOPRO® 595**  
Only for unsheathed linking cables

926063

## SOPROTIPS



**SOPROTIPS for SOPROLIFE® and SOPROCARE®**  
Protection tip against light.  
Sterilization by autoclave.  
(Set of 4 pieces)

990135

# COLOR IMAGERY

Cameras  
Cables

## LINKING CABLES



**LINKING CABLE 2.5m**  
With connector on both sides  
SOPROLIFE®/Sopro® 717/Sopro® 617

922050

**LINKING CABLE 5m**  
With connector on both sides  
SOPROLIFE®/Sopro® 717/Sopro® 617

922051

**LINKING CABLE 7m**  
With connector on both sides  
SOPROLIFE®/Sopro® 717/Sopro® 617

922120

## VIDEO CABLES



**VIDEO CABLE**  
With RCA/RCA connector  
Length: 1.5m

002003



**VIDEO CABLE**  
With YC/YC connector  
Length: 1.5m

002004

**S-VIDEO CABLE**  
With YC/YC connector  
Length: 5m

700012

## USB CABLES



**USB2.0 CABLE**  
A/B type.  
Length: 2m

002081

**USB2.0 CABLE**  
A/B type.  
Length: 5m

002091

**MINI USB2.0 CABLE**  
Only for Dock U-USB2  
Length: 5m

002148



**USB2.0 ACTIVE REPETER CABLE (Booster)**  
Length: 5m

700381

# COLOR IMAGERY

Cameras  
Windows Connection

## WINDOWS CONNECTION

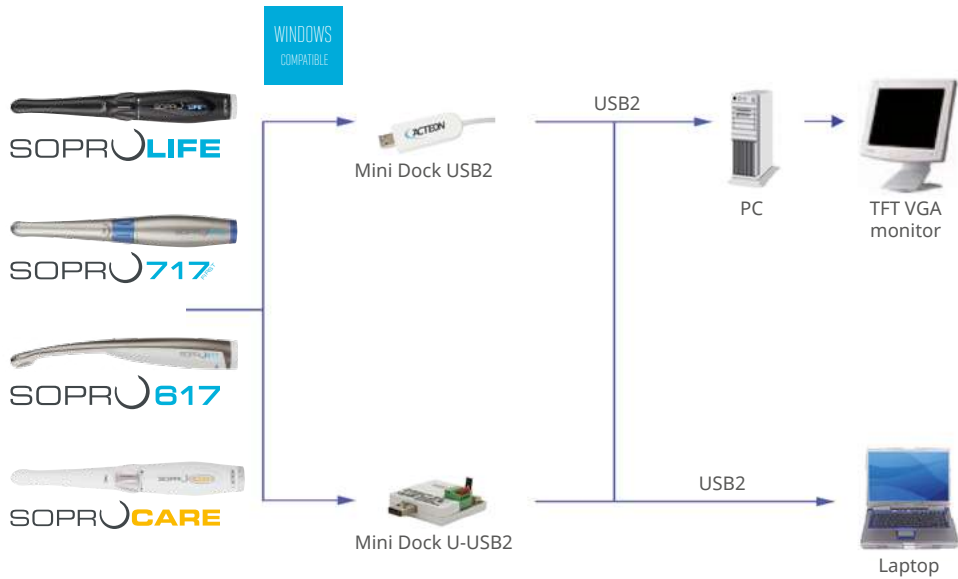

# COLOR IMAGERY

Cameras  
Mac Connection

## MAC CONNECTION

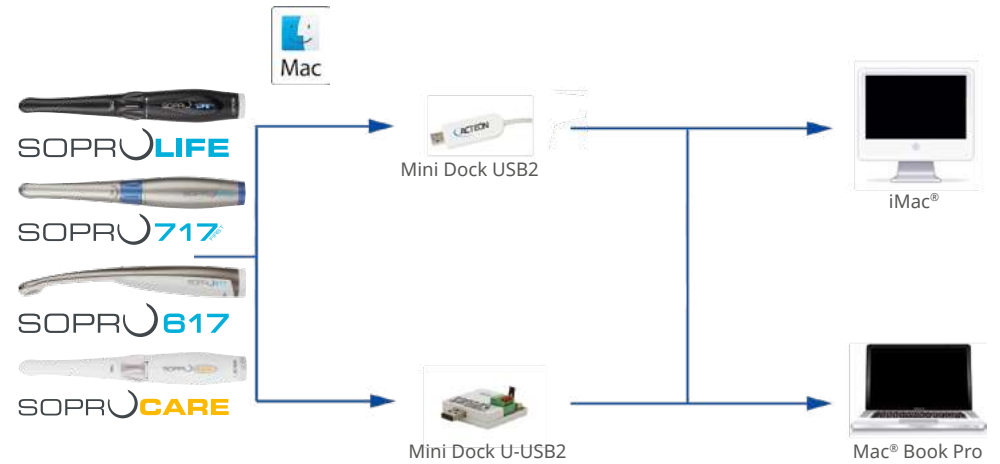

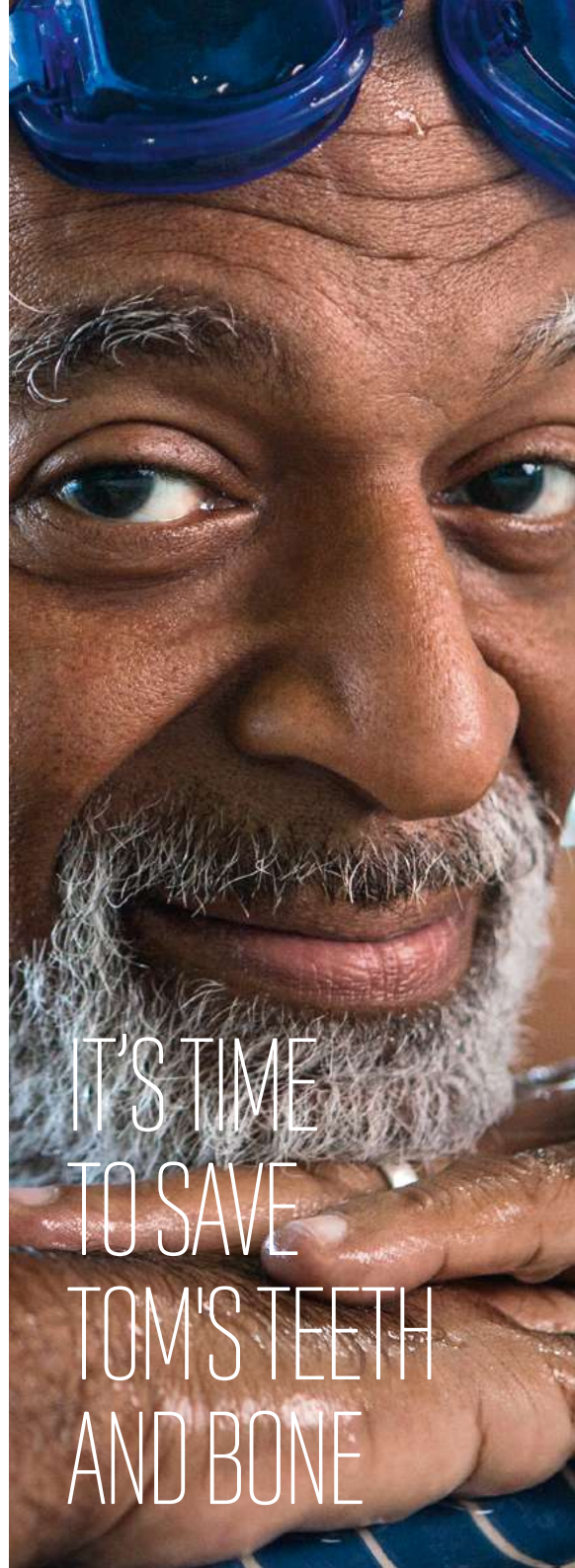

## ACTEON EQUIPMENT

IT'S TIME  
TO SAVE  
TOM'S TEETH  
AND BONE





SURGERY

www.acteongroup.com

Equipment  
YouTube Channel



PIEZOTOME® Cube  
brochure

**Surgery**.....

- PIEZOTOME® Cube .....72
- ImplantCenter™ 2 .....74
- Accessories.....77
- Surgery Tips & Kits.....79
- Implant Motors Accessories .....88
- Servotome® .....90



# SURGERY

Piezotome® Cube

## PIEZOTOME CUBE

Adopt **PIEZOTOME®** extraction to favor bone preservation with immediate implant placement



### PIEZOTOME® CUBE

with Essential kit

**F50100** ■

Delivered with a multifunction footswitch, a PIEZOTOME® CUBE LED handpiece, 1 handpiece holder, an Essential II kit (6 tips: BS1S, BS4, SL1, SL2, SL3 et LC2), a PIEZOTOME® autoclave dynamometric wrench, 1 bracket, 2 sterilizable irrigation lines, 5 clips and 15 perforators.

### PIEZOTOME® CUBE

with Universal kit

**F50113** ■

Delivered with a multifunction footswitch, a PIEZOTOME® CUBE LED handpiece, 1 handpiece holder, an Universal kit (6 tips: BS6, LC1, LC2, CE1, CE3 et PZ1), a PIEZOTOME® autoclave dynamometric wrench, 1 bracket, 2 sterilizable irrigation lines, 5 clips and 15 perforators.

For more information, please consult our website



[www.acteongroup.com/en/products/equipment](http://www.acteongroup.com/en/products/equipment)

*Class IIa medical devices (GMED) - CE 0459 - Manufacturer: SATELEC® - France*

# SURGERY

Piezotome® Cube  
Accessories

## PIEZOTOME® CUBE ACCESSORIES



### PIEZOTOME® CUBE LED HANDPIECE

Compatible with 2<sup>nd</sup> generation piezo tips → ■  
*Class IIa medical device (GMED) - CE 0459 - Manufacturer: SATELEC® - France*

**F12816**



### MULTIFUNCTION FOOTSWITCH PIEZOTOME® CUBE

**F50109**



### HANDPIECE HOLDER

**F50133**



### PIEZOTOME® AUTOCLAVABLE DYNAMOMETRIC WRENCH

**F50150**



### IRRIGATION LINE CLIPS x10

**F50116**



### BRACKET FOR PIEZOTOME® CUBE LED

**F50129**



### LIGHT RING PIEZOTOME® CUBE LED handpiece

**F12828**

## FOR FURTHER INFORMATION



Piezotome® Cube  
& Tips  
Catalog  
Réf. D50111

Around Piezotome® Cube video

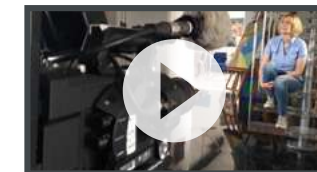

# SURGERY

## ImplantCenter™ 2

# IMPLANT CENTER 2



### Functions

- I-Surge™: Rotative Surgery Motor
- Piezotome®: Piezo electric surgery
- Newtron®: Conventional ultrasound treatment (Scaling, perio, endo, apical surgery,...)

F27200 ■

Delivered with a LED motor, a LED motor cord, a progressive footswitch, 2 brackets, 2 handpiece holders, 2 autoclavable irrigation lines and 30 perforators.

This reference does not include the Piezotome® 2 handpiece and tips.

*Class IIa medical device (GMED) - CE 0459 - Manufacturer: SATELEC® - France*



# ImplantCenter™ 1 & 2 Accessories

# SURGERY

## IMPLANTCENTER™ & IMPLANTCENTER™ 2 ACCESSORIES



IMPLANTCENTER™ PROGRESSIVE FOOTSWITCH ■ F27120



IMPLANTCENTER™ 2 PROGRESSIVE FOOTSWITCH ■ F27170



SUPPORT FOR MOTOR OR HANDPIECE ■ F02463



BRACKET FOR IMPLANTCENTER™ OR IMPLANTCENTER™ 2 ■ E27113

## IMPLANTCENTER™ 2 WITH LED MOTOR ACCESSORIES



I-SURGE™ LED LIGHT MICRO-MOTOR ■ F27210  
*Class IIa medical devices (GMED) - CE 0459 - Manufacturer: SATELEC® - France*



DISCONNECTABLE I-SURGE™ LED MICRO-MOTOR CORD ■ F27211



20:1 BIEN-AIR\* LED CONTRA-ANGLE green ring ■ F36132  
*Class IIa medical device - CE 0120 - Manufacturer: Bien Air - Distributor: Satelec - France*

## IMPLANTCENTER™ & IMPLANTCENTER™ 2 WITH NON LED MOTOR ACCESSORIES



I-SURGE™ LED LIGHT MICRO-MOTOR ■ F27123  
*Class IIa medical device (GMED) - CE 0459 - Manufacturer: SATELEC® - France*



DISCONNECTABLE I-SURGE™ MICRO-MOTOR CORD ■ F27124



DISCONNECTABLE I-SURGE™ MICRO-MOTOR CORD + MICRO-MOTOR ■ F34450  
*Class IIa medical device (GMED) - CE 0459 - Manufacturer: SATELEC® - France*



MONT BLANC 20:1 ANTHOGRY\* CONTRA-ANGLE GREEN RING (non LED) ■ F36140  
*Class IIa medical device (GMED) - CE 0459 - Manufacturer: Anthogyr - Distributor: Satelec - France*



ATOMIZER DROPPER ■ F36141  
for Mont Blanc 20:1 Anthogyr\* contra-angle

# SURGERY

## Warning

### WARNING

Some accessories adapted to PIEZOTOME® 2, PIEZOTOME® Solo, PIEZOTOME® Cube and IMPLANTCENTER™ 2 are not compatible with the first generation PIEZOTOME® and IMPLANTCENTER™, and vice-versa

- References compatible with 1<sup>st</sup> generation devices are indicated by a blue square : ■
- References compatible with 2<sup>nd</sup> and 3<sup>rd</sup> generation devices are indicated by a grey square : ■

### 1<sup>ST</sup> GENERATION



### 2<sup>ND</sup> GENERATION



### 2<sup>ND</sup> GENERATION



# SURGERY

## Accessories

### IMPORTANT

The handpieces are equipped with keyway systems to prevent a Piezotome® (Bone Surgery, Sinus Lift, Extraction, etc. insert) from being screwed onto a Newtron® handpiece or a classic insert (scaling, periodontics, endodontics, etc.) from being screwed onto a Piezotome® handpiece.



#### PIEZOTOME® HANDPIECE + CORD

Class IIa medical device (GMED) - CE 0459 - Manufacturer: SATELEC® - France

■ F57321



#### NEWTRON® HANDPIECE

Class IIa medical device (GMED) - CE 0459 - Manufacturer: SATELEC® - France

■ ■ F12281



#### NEWTRON® CORD

for PIEZOTOME® and IMPLANTCENTER™

■ F57305



#### NEWTRON® CORD

for PIEZOTOME® 2 and IMPLANTCENTER™ 2

■ F12850



#### PIEZOTOME® LED HANDPIECE + CORD

Class IIa medical device (GMED) - CE 0459 - Manufacturer: SATELEC® - France

■ F12815



#### LIGHT RING

for PIEZOTOME® 2 and for PIEZOTOME® Solo handpieces

■ F12821



#### NEWTRON® LED HANDPIECE

for PIEZOTOME® 2 and IMPLANTCENTER™ 2

■ F12609



#### NEWTRON® LED CORD

for PIEZOTOME® 2 and IMPLANTCENTER™ 2

■ F12830



#### PIEZOTOME® SOLO HANDPIECE + CORD

■ F57509



#### PIEZOTOME® AUTOCLAVABLE DYNAMOMETRIC WRENCH

■ ■ F50150

# SURGERY

## Accessories



### IMPLANTCENTER™ CART

Dimensions (DxWxH) : 66 x 54 x 79cm  
3 glass trays: 60 x 50cm  
connections for water and electricity

■ ■ F27125



### PIEZOTOME® 2 PACK (without tip)

Delivered with an autoclavable PIEZOTOME® 2 handpiece with cord and a PIEZOTOME® wrench

■ ■ F87523

*Class IIa medical devices (GMED) - CE 0459 - Manufacturer: SATELEC® - France*



### STERILIZATION BOX

■ ■ F27156



### UNIVERSAL IRRIGATION LINES STERILE x10

Single-use with integrated cassette and flow control system

■ ■ F57370

*Class IIa medical device (GMED) - CE 0459 -Manufacturer: SATELEC® - France*



### AUTOCLAVABLE IRRIGATION LINE x1 + 10 sterile perforators

■ ■ F57374

*Irrigation line: Class I medical device (GMED) - CE  
Perforators: Class Is medical devices (GMED) - CE 0459  
Manufacturer: SATELEC® - France*



### AUTOCLAVABLE IRRIGATION LINE x1

■ ■ E57374

*Irrigation line: Class I medical device (GMED) - CE*



### DISPOSABLE STERILE PERFORATORS x10

■ ■ F57372

*Perforators: Class Is medical devices (GMED) - CE 0459*



### IRRIGATION LINE CLIP

■ ■ E57353



### PIEZOTOME® 2 PROGRESSIVE FOOTSWITCH

■ ■ F57404



### PIEZOTOME® SOLO AND PIEZOTOME® SOLO LED FOOTSWITCH

■ ■ F57504



### BRACKET

for IMPLANTCENTER™, IMPLANTCENTER™ 2,  
PIEZOTOME® 2, PIEZOTOME® Solo  
et PIEZOTOME® Solo LED

■ ■ E27113

# SURGERY

## Osteotomy - Osteoplasty



### BONE SURGERY (BS) PACK

Delivered with an autoclavable PIEZOTOME® handpiece with cord, a Bone Surgery kit and a PIEZOTOME® autoclave dynamometric wrench

■ ■ F87500



### BONE SURGERY KIT

BS1S II, BS2L II, BS2R II, BS4 II, BS5 II, BS6 II tips, an autoclavable metal support, an autoclavable universal wrench

■ ■ F87509

### BONE SURGERY KIT SUPPORT

■ X88454\* ■ X88456



### SAWS

BS2L - Left-angled  
BS2R - Right-angled

■ ■ F87302\* ■ F87502  
■ ■ F87303\* ■ F87503



BS1S "Slim" - Depth of cut 9mm

■ ■ F87525

BS1L "Long" - Depth of cut 15mm  
with universal wrench

■ ■ F87527



BS1 RD - Rounded saw, 280°  
of active surface

■ ■ F87557



### SCRAPERS

BS4  
BS5  
BS6

■ ■ F87304\* ■ F87504  
■ ■ F87305\* ■ F87505  
■ ■ F87306\* ■ F87506

*\*Discontinued, available until stock runs out*

*Class IIa medical devices (GMED) - CE 0459 - Manufacturer: SATELEC® - France*



# SURGERY

## Sinus Lift



### SINUS LIFT (SL) PACK

Delivered with a sterilization box, an autoclavable PIEZOTOME® handpiece with cord, a Sinus Lift kit and a PIEZOTOME® autoclavable dynamometric wrench

■ F87510



### SINUS LIFT KIT

SL1, SL2, SL3, SL4, SL5 tips, an autoclavable metal support, an autoclavable universal wrench

■ F87319\* ■ F87519

### SINUS LIFT KIT SUPPORT

■ X88455\* ■ X88457

### SINUS LIFT TIPS



SL1  
SL2

■ F87311\* ■ F87511  
■ F87312\* ■ F87512



SL3  
SL4

■ F87313\* ■ F87513  
■ F87314\* ■ F87514



SL5

■ F87315\* ■ F87515

\*Discontinued, available until stock runs out

For more information, please consult our website



[www.acteongroup.com/en/products/equipment](http://www.acteongroup.com/en/products/equipment)

# SURGERY

## Intralift™



### INTRALIFT™ PACK

Delivered with a sterilization box, an autoclavable PIEZOTOME® handpiece with cord, an Intralift kit, an autoclavable universal wrench

■ F87530



### INTRALIFT™ KIT

TKW1, TKW2, TKW3, TKW4, TKW5 tips, an autoclavable metal support, an autoclavable universal wrench

■ F87536

### INTRALIFT™ KIT SUPPORT

■ X88458

### INTRALIFT™ TIPS



TKW1 - Conical tip ø1.35mm (pilot drilling)

■ F87331\* ■ F87531

TKW2 - Cylindrical tip ø2.1mm (preliminary drilling)

■ F87332\* ■ F87532



TKW3 - Cylindrical tip ø2.35mm (preliminary drilling)

■ F87333\* ■ F87533

TKW4 - Cylindrical tip ø2.8mm (secondary drilling)

■ F87334\* ■ F87534



TKW5 - Non cutting "trumpet" tip (sinus membrane elevation)

■ F87335\* ■ F87535

\*Discontinued, available until stock runs out

# SURGERY

## Extraction



### EXTRACTION PACK

Delivered with a sterilization box, an autoclavable PIEZOTOME® handpiece with cord, an Extraction kit and a PIEZOTOME® autoclavable dynamometric wrench

■ **F87540**



### EXTRACTION KIT

LC1, LC2 (x2), LC2L, LC2R, Ninja® tips, an autoclavable metal support, an autoclavable universal wrench

■ **F87546**

### EXTRACTION KIT SUPPORT

■ **X88459**

### EXTRACTION TIPS



LC1  
LC2

■ **F87307\*** ■ **F87507**  
■ **F87542**



LC2L  
LC2R

■ **F87343\*** ■ **F87543**  
■ **F87344\*** ■ **F87544**



Ninja®

■ **F87345\*** ■ **F87545**

*\*Discontinued, available until stock runs out*

# SURGERY

## Crown Extension



### CROWN EXTENSION (CE) PACK

Delivered with a sterilization box, an autoclavable PIEZOTOME® handpiece with cord, a Crown Extension kit and a PIEZOTOME® autoclavable dynamometric wrench

■ **F87550**



### CROWN EXTENSION KIT

BS6, CE1, CE2, CE3 tips, an autoclavable metal support, an autoclavable universal wrench

■ **F87554**

### CROWN EXTENSION TIPS



CE1 - Diamond-coated spherical tip  
ø1.75mm  
CE2 - Diamond-coated spherical tip  
ø1.20mm  
CE3 - Diamond-coated straight tip  
on 5mm (laser mark placed at  
3mm: biologic width)

■ **F87351\*** ■ **F87551**

■ **F87352\*** ■ **F87552**

■ **F87353\*** ■ **F87553**



BS6

■ **F87306\*** ■ **F87506**

*\*Discontinued, available until stock runs out*

For more information, please consult our website



[www.acteongroup.com/en/products/equipment](http://www.acteongroup.com/en/products/equipment)

# SURGERY

## Crest Splitting



### CREST SPLITTING (CS) PACK

Delivered with a sterilization box, an autoclavable PIEZOTOME® LED handpiece with cord, a Crest Splitting kit and a PIEZOTOME® autoclavable dynamometric wrench

■ **F87560**



### CREST SPLITTING KIT

CS1, CS2, CS3, CS4, CS5, CS6, tips, an autoclavable metal support, an autoclavable universal wrench

■ **F87567**

### CREST SPLITTING KIT SUPPORT

■ **X88464**

### CREST SPLITTING TIPS



CS1  
CS2

■ **F87561**  
■ **F87562**



CS3  
CS4

■ **F87563**  
■ **F87564**



CS5  
CS6

■ **F87565**  
■ **F87566**

# Piezocision™

# SURGERY

### PIEZOCISION™ PACK

Delivered with a sterilization box, an autoclavable PIEZOTOME® LED handpiece with cord, a Piezocision™ kit and an autoclavable universal wrench

■ **F87570**



### PIEZOCISION™ KIT

PZ1, PZ2L, PZ3R, PZ3 tips, an autoclavable metal support and an autoclavable universal wrench

■ **F87576**

### PIEZOCISION™ KIT SUPPORT

■ **X88472**

### PIEZOCISION™ TIPS



PZ1 - Anterior corticotomies

■ **F87571**



PZ2L (left oriented)  
Lateral corticotomies on patient's right vestibular arch  
*To be used with pendulum motion*

PZ2R (right oriented)  
Lateral corticotomies on patient's left vestibular arch  
*To be used with pendulum motion*

■ **F87572**  
■ **F87573**

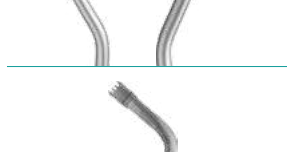

PZ3 - Anterior corticotomies for root proximity concerns

■ **F87574**



# SURGERY

## Essential



### ESSENTIAL PACK

Delivered with a sterilization box, an autoclavable PIEZOTOME® 2 handpiece with cord and an Essential Kit

■ F87529



### ESSENTIAL KIT

BS1 Slim II, BS4 II, SL1 II, SL2 II, SL3 II, LC2 II tips, an autoclavable metal support, an autoclavable universal wrench

■ F87528



### UNIVERSAL KIT

BS6 II, LC1 II, LC2 II, CE1 II, CE3 II, PZ1 II tips, an autoclavable metal support, an autoclavable universal wrench

■ F87539

For more information, please consult our website



[www.acteongroup.com/en/products/equipment](http://www.acteongroup.com/en/products/equipment)

# SURGERY

## Newtron® Packs & Kits



### NEWTRON® PERIO PACK

Delivered with a sterilization box, an autoclavable NEWTRON® handpiece, an autoclavable NEWTRON® cord, a NEWTRON® Perio kit and a Piezotome® autoclavable dynamometric wrench

■ F87520

### NEWTRON® PACK (without tip)

Delivered with a sterilization box, an autoclavable NEWTRON® LED handpiece, an autoclavable LED cord and a PIEZOTOME® autoclavable dynamometric wrench

■ F87524

### IMPORTANT

NEWTRON® kits are compatible with the NEWTRON® and NEWTRON® LED handpieces



### NEWTRON® IMPLANT PROTECT KIT

Tips IP1, IP2L, IP2R, IP3L et IP3R, an autoclavable metal support, an autoclavable universal wrench

■ ■ F02120



### NEWTRON® MICRO-RETRO KIT

P14D, P15LD, P15RD tips, an autoclavable metal support, an autoclavable universal wrench

■ ■ F87325\*



### NEWTRON® KIT SUPPORT

■ ■ X88451

\*Discontinued, available until stock runs out

# SURGERY

Implant Motors  
Accessories

## I-SURGE™ - ACCESSORIES



**I-SURGE™ NON-AUTOCCLAVABLE «IMPLANT» MICROMOTOR**

*Class IIa medical device (GMED) - CE 0459 - Manufacturer: SATELEC® - France*

**F28971**



**I-SURGE™ AUTOCLAVABLE «IMPLANT» MICROMOTOR**

*Class IIa medical device (GMED) - CE 0459 - Manufacturer: SATELEC® - France*

**F28970**



**MONT BLANC 20:1 ANTHOGRY\* CONTRA-ANGLE GREEN RING (NON LED)**

*Class IIa medical device (GMED) - CE 0459  
Manufacturer: Anthogyr - Distributor: Satelec - France*

**F36140**



**ATOMIZER DROPPER**  
for Mont Blanc 20:1 Anthogyr\* contra-angle

**F36141**



**FOOTSWITCH**  
for I-Surge™ non-autoclavable micromotor

**F28965**



**I-SURGE™ MULTIFUNCTION FOOTSWITCH**

**F28966**



**UNIVERSAL IRRIGATION LINES STERILE x10**  
single-use with integrated cassette and flow control system

*Class Is medical devices (GMED) - CE 0459 - Manufacturer: SATELEC® - France*

**F57370**



**AUTOCLAVABLE IRRIGATION LINE x1**  
+ 10 sterile perforators

*Irrigation line: Class I medical device (GMED) - CE  
Perforators: Class Is medical devices (GMED) - CE 0459  
Manufacturer: SATELEC® - France*

**F57374**



**AUTOCLAVABLE IRRIGATION LINE x1**

*Class I medical devices - CE - Manufacturer: SATELEC® - France*

**E57374**



**DISPOSABLE STERILE PERFORATORS x10**

*Perforators: Class Is medical devices (GMED) - CE 0459  
Manufacturer: SATELEC® - France*

**F57372**



**IRRIGATION LINE CLIP**

**E57353**

# SURGERY

Implant Motors  
Accessories



**I-SURGE™ POWER SUPPLY**

**F28955**



**BRACKET**

**F28967**



**MICROMOTOR HOLDER**  
white silicone

**F02463**

## I-SURGE™ + & HT-IMPLANT - ACCESSORIES



**I-SURGE™+ FOOTSWITCH**

**F28966**



**HT-IMPLANT FOOTSWITCH**

**F28965**



**IRRIGATION LINES x10**

*Class I medical devices - CE - Manufacturer: SATELEC® - France*

**F28750**

## SUNI MOTOR - ACCESSORIES



**SUNI IRRIGATION LINES KIT x5**

*Class Is medical device (GMED) - CE 0459 - Manufacturer: SATELEC® - France*

**F34700**



**SUNI IRRIGATION LINES KIT x10**

*Class Is medical device (GMED) - CE 0459 - Manufacturer: SATELEC® - France*

**F34702**

## MISCELLANEOUS MOTORS - ACCESSORIES



**PACK OF IML MICRO-MOTOR O'RINGS**

**F29100**



**MICRO-MOTOR CARBON BRUSHES BOX x2**

*Discontinued, available until stock runs out*

**F29101**

# SURGERY

Electrosurge

## SERVOTOME



### SERVOTOME® II

High frequency electrosurge for orthodontics, periodontics and other oral surgery

F57210

Delivered with a single footswitch, a box with 10 electrodes, a conductive bracelet.

*Class IIb medical device (GMED) - CE 0459 - Manufacturer: SATELEC® - France*

### SERVOTOME - ACCESSORIES



CONDUCTIVE BRACELET

F57226



ELECTRODE HOLDER

*Class IIb medical devices (GMED) - CE 0459 - Manufacturer: SATELEC® - France*

F00476



ELECTRODE HOLDER CORD (2m)

F00475



SERVOTOME® II CAPACITIVE COUPLER

*Discontinued, available until stock runs out*

F00485



SERVOTOME® II FOOTSWITCH

F00059



SERVOTOME® CLASSIC FOOTSWITCH

F00039

# SURGERY

Electrosurge  
Electrodes



10 ELECTRODES KIT

F10440

10 ELECTRODES + 1 ELECTRODE HOLDER KIT

F10472



I 22 S

F10421



I 22 CA

F10422



TR 22 L

F10424



TR 22 R

F10425



TR 22 T

F10427



FC 25 B

F10428



FC 32 B

F10429



FC 10 N

F10430



I 40 S

F10431



I 40 CA

F10432



## ULTRASONICS

[www.acteongroup.com](http://www.acteongroup.com)

Equipment  
YouTube Channel



NEWTRON® brochure

<b>Ultrasonics</b> .....	
NEWTRON® P5XS B.LED.....	94
NEWTRON® P5 B.LED.....	96
NEWTRON® Booster.....	98
NEWTRON® Tips.....	102
NEWTRON® kits.....	108
Wrenches.....	112
Boxes & Support.....	113
Range IV Accessories.....	114
Range III Accessories.....	116
Range II Accessories.....	118
Range I Accessories.....	120
Overview Irrigation Lines.....	122



# ULTRASONICS

## NEWTRON® P5 XS BLED Ultrasonic Generators

# NEWTRON

P5XS BLED



### NEWTRON® P5 XS B.LED

F62100

Delivered with a non-disconnectable footswitch, a power supply, a NEWTRON® SLIM B.LED handpiece cord, a NEWTRON® SLIM B.LED handpiece with a blue ring, a NEWTRON® SLIM B.LED white LED ring, a F.L.A.G™ for B.LED (5x 1.5ml) dental plaque discloser, an autoclavable universal wrench, 3 tips (N°1, N°1S, N°H3) and a 300ml tank

*Class IIa medical device (GMED) - CE 0459 - Manufacturer: SATELEC® - France*



#### IMPORTANT

Handpieces compatible with all ACTEON® Equipment  
Dental Tips (with color coded ring: Color Coding System™)

# ULTRASONICS

## NEWTRON® P5 XS BLED Accessories



**NEWTRON® SLIM B.LED HANDPIECE**  
with blue LED ring

*Class IIa medical device (GMED) - CE 0459 - Manufacturer: SATELEC® - France*

F12900



**NEWTRON® SLIM B.LED HANDPIECE**  
with white LED ring

*Class IIa medical device (GMED) - CE 0459 - Manufacturer: SATELEC® - France*

F12905



**NEWTRON® SLIM B.LED BLUE LED RING**

F62201



**NEWTRON® SLIM B.LED WHITE LED RING**

F12915



**NEWTRON® SLIM B.LED HANDPIECE CORD**  
non-disconnectable

X00226



**FOOTSWITCH**

F00061



**HANDPIECE HOLDER**  
silicone

E60108



**300ml TANK**

F62004



**500ml TANK**

F62005



**DENTAL PLAQUE DISCLOSER**  
F.L.A.G.™ FOR B.LED 5 x 1.5ml

F62200



**DENTAL PLAQUE DISCLOSER**  
F.L.A.G.™ FOR B.LED 100ml

F62203

# ULTRASONICS

## NEWTRON® P5 BLED Ultrasonic Generators

# NEWTRON

P5 BLED



### NEWTRON® P5 B.LED

F61101

Delivered with a non-disconnectable footswitch, a power supply, a NEWTRON® SLIM B.LED handpiece cord, a NEWTRON® SLIM B.LED handpiece with a blue ring, a NEWTRON® SLIM B.LED white LED ring, a F.L.A.G.™ for B.LED (5x 1.5ml) dental plaque discloser, a N°1 tip and an autoclavable universal wrench

*Class IIa medical device (GMED) - CE 0459 - Manufacturer: SATELEC® - France*



#### IMPORTANT

Handpieces compatible with all ACTEON® Equipment  
Dental Tips (with color coded ring: Color Coding System™)

# ULTRASONICS

## NEWTRON® P5 BLED Accessories



**NEWTRON® SLIM B.LED HANDPIECE**  
with blue LED ring

*Class IIa medical device (GMED) - CE 0459 - Manufacturer: SATELEC® - France*

F12900



**NEWTRON® SLIM B.LED HANDPIECE**  
with white LED ring

*Class IIa medical device (GMED) - CE 0459 - Manufacturer: SATELEC® - France*

F12905



**NEWTRON® SLIM B.LED BLUE LED RING**

F62201



**NEWTRON® SLIM B.LED WHITE LED RING**

F12915



**NEWTRON® SLIM B.LED HANDPIECE CORD**  
non-disconnectable

X00226



**FOOTSWITCH**

F00061



**HANDPIECE HOLDER**  
silicone

E60108



**DENTAL PLAQUE DISCLOSER**  
F.L.A.G.™ FOR B.LED 5 x 1.5ml

F62200



**DENTAL PLAQUE DISCLOSER**  
F.L.A.G.™ FOR B.LED 100ml

F62203

# ULTRASONICS

## NEWTRON® Booster Ultrasonic Generators

# NEWTRON BOOSTER



## NEWTRON® BOOSTER

F60203

Delivered with a NEWTRON® non-disconnectable footswitch, a power supply, a NEWTRON® handpiece cord, a NEWTRON® handpiece, a N°1 tip and an autoclavable universal wrench

*Class IIa medical device (GMED) - CE 0459 - Manufacturer: SATELEC® - France*



### IMPORTANT

Handpieces compatible with all ACTEON® Equipment Dental Tips (with color coded ring: Color Coding System™)

# ULTRASONICS

## NEWTRON® Booster Accessories



**NEWTRON® HANDPIECE**  
without LED, autoclavable light grey/dark grey  
*Class IIa medical device (GMED) - CE 0459 - Manufacturer: SATELEC® - France*

F12281



**NEWTRON® BOSTER HANDPIECE CORD**  
non-disconnectable

X00244



**FOOTSWITCH**  
non-disconnectable

F00028



**HANDPIECE HOLDER**  
silicone

E60108

For more information, please consult our website



[www.acteongroup.com/en/products/equipment](http://www.acteongroup.com/en/products/equipment)

# ULTRASONICS

Dental Tips

## COLOR CODING SYSTEM™

Color recognition mode

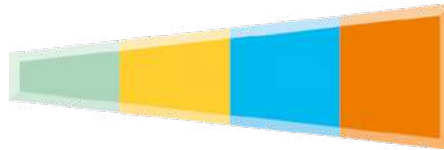

With more than 80 tips, ACTEON® offers the widest range of instruments covering the clinical areas of prophylaxis, periodontics, implant care, endodontics and prosthesis.

The Color Coding System™ (CCS) intuitively associates each tip with one of the four available power ranges. These parameters allow to have a safe intervention while durably preserving your tips.

### PERIODONTICS



### IMPLANT CARE



LOW POWER - Delicate treatment

### ENDODONTICS



### SURGICAL ENDODONTICS

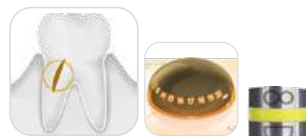

MEDIUM POWER - Precise treatment

### PROPHYLAXIS



HIGH POWER  
Routine prophylaxis treatment

### CONSERVATIVE AND RESTORATIVE DENTISTRY



VERY HIGH POWER  
Special treatments requiring the full force of ultrasonics

# ULTRASONICS

Dental Tips

## TIPCARDS



### SCALING TIPCARD

Tip wear guide for scaling tips

D00247



### PERIO TIPCARD

Tip wear guide for periodontal tips

D00248

## TIPS DOCUMENTATION



### LEAFLET "DENTAL TIPS - PRESERVE TEETH"

D00601



## COMPENDIUM



### ULTRASONIC DENTISTRY COMPENDIUM

D08399

# ULTRASONICS

## Dental Tips

### scaling



#### Scaling



**N°1**  
F00246  
Universal



**N°2**  
F00247  
High power



**N°3**  
F00248  
Removing stains



**10P**  
F00253  
Supra and sub-gingival < 3mm



**10X**  
F00259  
Interproximal



**10Z**  
F00254  
Subgingival



**N°1S**  
F00245  
Supra and sub-gingival

### periodontics



#### Curettes & debridement



**H1**  
F00366  
Anterior teeth, diamond-coated



**H2L**  
F00367  
Premolars & molars, left-angled



**H2R**  
F00368  
Premolars & molars, right-angled



**H3**  
F00369  
Anterior teeth, curette



**H4L**  
F00114  
Premolars & molars, left-angled



**H4R**  
F00115  
Premolars & molars, right-angled

### perioFine



#### Periofine



**PFU**  
F02170  
Universal



**PFL**  
F02171  
Left-angled



**PFR**  
F02172  
Right-angled

# ULTRASONICS

## Dental Tips

### implantProtect

Pure Titanium



#### Peri-implantitis treatment



**IP1**  
F02121  
Implant abutments and wide threads



**IP2L**  
F02122  
Medium implant threads, left-angled



**IP2R**  
F02123  
Medium implant threads, right-angled



**IP3L**  
F02124  
Narrow implant threads, left-angled



**IP3R**  
F02125  
Narrow implant threads, right-angled

### perioSoft

#### implant maintenance



**PH1 (x4)**  
F00702  
Anterior teeth



**PH2L (x4)**  
F00705  
Premolars & molars, left-angled



**PH2R (x4)**  
F00706  
Premolars & molars, right-angled

### perioMaintenance

BDR



#### Periodontal Maintenance



**TK1-1S**  
F01001  
Short probe



**TK1-1L**  
F01004  
Long probe



**TK2-1L**  
F02162  
Premolars & molars, left-angled



**TK2-1R**  
F02161  
Premolars & molars, right-angled

### perioPrecision

#### PerioPrecision



**P2L**  
F00090  
Narrow pockets debridement, left-angled



**P2R**  
F00091  
Narrow pockets debridement, right-angled



# ULTRASONICS

## Dental Tips

### endodontics



#### Endodontics - Irrigation

 <b>K10-21 (x4)</b> <b>F43710</b> Ø 0.1/length 21mm	 <b>K10-25 (x4)</b> <b>F43712</b> Ø 0.1/length 25mm
 <b>K15-21 (x4)</b> <b>F43715</b> Ø 0.15/length 21mm	 <b>K15-25 (x4)</b> <b>F43717</b> Ø 0.15/length 25mm
 <b>K25-21 (x4)</b> <b>F43725</b> Ø 0.25/length 21mm	 <b>K25-25 (x4)</b> <b>F43727</b> Ø 0.25/length 25mm
 <b>K30-21 (x4)</b> <b>F43730</b> Ø 0.3/length 21mm	 <b>K30-25 (x4)</b> <b>F43732</b> Ø 0.3/length 25mm

### irrisafe



#### Passive Ultrasonic Irrigation

 <b>IRR 20-21 (x4)</b> <b>F43807</b> Ø 0.2/length 21mm	 <b>IRR 20-25 (x4)</b> <b>F43808</b> Ø 0.2/length 25mm
 <b>IRR 25-21 (x4)</b> <b>F43805</b> Ø 0.25/length 21mm	 <b>IRR 25-25 (x4)</b> <b>F43806</b> Ø 0.25/length 25mm

### endosurgery



#### Apical surgery

 <b>P14D</b> <b>F00106</b> Universal	 <b>S12-70D</b> <b>F00118</b> 70° Universal
 <b>P15LD</b> <b>F00107</b> Left-angled	 <b>P15RD</b> <b>F00108</b> Right-angled

# ULTRASONICS

## Dental Tips

### endodontics



#### Retreatment

 <b>ET40</b> <b>F88012</b> Length 40mm	 <b>ET40D</b> <b>F88014</b> Length 40mm, diamond-coated
 <b>ET20D</b> <b>F88013</b> Length 20mm, diamond-coated	 <b>SO4</b> <b>F88009</b> Gutta Percha condenser

### endosuccess



#### Apical surgery

 <b>AS3D</b> <b>F00065</b> Length 3mm Universal	 <b>AS6D</b> <b>F00079</b> Length 6mm	 <b>AS9D</b> <b>F00067</b> Length 9mm
 <b>ASLD</b> <b>F00080</b> Length 3mm, left-angled (premolars)	 <b>ASRD</b> <b>F00081</b> Length 3mm, right-angled (premolars)	

### endosuccess



#### Retreatment

 <b>ET18D</b> <b>F88017</b> Cavity access finishing	 <b>ETBD</b> <b>F88020</b> Exploration	
 <b>ET25S</b> <b>F88021</b> Short Ti-Nb tip	 <b>ET25</b> <b>F88018</b> Ti-Nb tip	 <b>ET25L</b> <b>F88022</b> Long Ti-Nb tip
 <b>ET20</b> <b>F88011</b> Universal	 <b>ETPR</b> <b>F88019</b> Loosening	

### endosuccess



#### Canal Access Prep

 <b>CAP1</b> <b>F88181</b> Cavity preparation	 <b>CAP2</b> <b>F88182</b> Canal localization	 <b>CAP3</b> <b>F88183</b> Canal opening
---	---	--

# ULTRASONICS

## Dental Tips

### perfectmargin Rounded



#### Prosthetic finishing (rounded)



**PM1**  
F02250

Preparation of the dentin



**PM2**  
F02251

Preparation/finishing



**PM3**  
F02252

Finishing



**PM4**  
F02253

Corono-radicular preparation, conical, diamond-coated 46µm

### perfectmargin Veneers



#### Ceramic veneers finishing



**PMV1**  
F02021

Diamond-coated ball



**PMV2**  
F02022

Diamond-coated external spoon



**PMV3**  
F02023

Diamond-coated internal spoon



**PMV4**  
F02024

Smooth external spoon



**PMV5**  
F02025

Smooth internal spoon



**PMV6**  
F02026

Smooth ball

### perfectmargin Shoulder



#### Prosthetic finishing (shoulder)



**PMS1**  
F02254

Preparation of the dentin



**PMS2**  
F02255

Preparation/finishing



**PMS3**  
F02256

Finishing

# ULTRASONICS

## Dental Tips

### excavus



#### Excavation



**EX1**  
F02040

Occlusal surface



**EX2**  
F02041

Proximal surface



**EX3**  
F02042

Distal surface



**EX-R**  
F02043

45° angled to the right



**EX-L**  
F02044

45° angled to the left

#### Prosthesis



**C20**  
F00113

Inlay/onlay condensation



**Piezocem caps x10**  
F00397



**5AE**  
F00249

Loosening with spray

For more information, please consult our website



[www.acteongroup.com/en/products/equipment](http://www.acteongroup.com/en/products/equipment)

# ULTRASONICS

## Tips Kits

### scaling



**SCALING KIT**

Delivered with an autoclavable plastic box, N°1, N°1S, N°10X, H3 tips, four autoclavable dynamometric NEWTRON® wrenches

**F00934**

### hygiene



**HYGIENE KIT**

Delivered with an autoclavable plastic box, N°1, N°1S, 10Z, TK1-1S tips, four autoclavable dynamometric NEWTRON® wrenches

**F00935**

### excavus



**EXCAVUS® KIT**

Delivered with EX1, EX2, EX3, EX-L, EX-R tips, an autoclavable metal support and an autoclavable universal wrench

**F00739**

### periodontics



**PERIO KIT**

Delivered with an autoclavable plastic box, N°1S, H3, H4L, H4R tips, four autoclavable dynamometric wrenches

**F00936**

# ULTRASONICS

## Tips Kits

### perioPrecision



**PERIOPRECISION KIT**

Delivered with an autoclavable plastic box, P2L, P2R, TK1-1S tips and three autoclavable dynamometric NEWTRON® wrenches

**F00939**

### periomaintenance



**MAINTENANCE KIT (BDR)**

Delivered with an autoclavable plastic box, TK1-1S, TK1-1L, TK2-1L, TK2-1R tips, four autoclavable dynamometric NEWTRON® wrenches

**F00937**

### implantProtect



**IMPLANT PROTECT KIT**

Delivered with IP1, IP2L, IP2R, IP3L and IP3R tips, an autoclavable metal support and an autoclavable universal wrench

**F02120**

### endo-one



**ENDO ONE KIT**

Delivered with CAP1, CAP2, CAP3, ET25, ETPR tips, 1 blister of 4 IrriSafe™ 25-21mm tips, an autoclavable metal support and an autoclavable universal wrench

**F00732**

# ULTRASONICS

## Tips Kits



**ENDO SUCCESS™ RETREATMENT KIT**  
 Delivered with ET18D, ET20, ET25, ET25S, ETBD, ETPR tips, an autoclavable metal support and an autoclavable universal wrench

**F00737**



**ENDO SUCCESS™ CANAL ACCESS PREP KIT**  
 Delivered with CAP1, CAP2, CAP3 tips, an autoclavable metal support and an autoclavable universal wrench

**F88180**



**ENDO SUCCESS™ APICAL SURGERY KIT**  
 Delivered with AS3D, AS6D, AS9D, ASLD, ASRD tips, an autoclavable metal support and an autoclavable universal wrench

**F00069**

# ULTRASONICS

## Tips Kits



**PERFECT MARGIN® ROUNDED KIT**  
 Delivered with PM1, PM2, PM3, PM4 tips, an autoclavable metal support and an autoclavable universal wrench

**F00738**



**PERFECT MARGIN® SHOULDER KIT**  
 Delivered with PMS1, PMS2, PMS3, PM4 tips, an autoclavable metal support and an autoclavable universal wrench

**F00736**



**PERFECT MARGIN® VENEERS KIT**  
 Delivered with PMV1, PMV2, PMV3, PMV4, PMV5, PMV6 tips, an autoclavable metal support and an autoclavable universal wrench

**F02020**

# ULTRASONICS

## Wrenches

### WRENCHES



**NEWTRON® WRENCH**  
autoclavable and dynamometric

**F81330**

**IMPORTANT**

The NEWTRON® wrench is used with surgical endodontics tips: AS3D, AS6D, AS9D, ASLD, ASRD, S12-70D, P14D, P15LD et P15RD.  
For other tips with yellow ring, the universal wrench (Ref. F00406) is recommended.



**UNIVERSAL WRENCH**

**F00406**



**PROTEC-TIP**

**F81281**

For more information, please consult our website



[www.acteongroup.com/en/products/equipment](http://www.acteongroup.com/en/products/equipment)

# ULTRASONICS

## Boxes & Supports

### BOXES



**AUTOCLAVABLE PLASTIC BOX + 4 AUTOCLAVABLE DYNAMOMETRIC NEWTRON® WRENCHES**

**F12352**



**AUTOCLAVABLE PLASTIC BOX**  
for autoclavable dynamometric wrenches

**F12351**

### SUPPORTS



**NEWTRON® KIT SUPPORT**

**X88451**



**ENDO SUCCESS™ KIT SUPPORT**

**X88447**



**PERFECT MARGIN™ KIT SUPPORT**

**X88448**



**EXCAVUS® KIT SUPPORT**

**X88449**

# ULTRASONICS

Range IV  
Accessories

**RANGE IV:** NEWTRON® Booster, NEWTRON® P5, NEWTRON® P5 B.LED, NEWTRON® P5 XS B.LED, NEWTRON® P5 XS B.LED Bluetooth



## HANDPIECES



### IMPORTANT

Handpieces compatible with all ACTEON® Equipment Dental Tips (with color coded ring: Color Coding System™)



### NEWTRON® HANDPIECE

without LED, autoclavable, light grey/dark grey  
For NEWTRON® Booster

F12281

*Class IIa medical device (GMED) - CE 0459 - Manufacturer: SATELEC® - France*



### NOSE FOR NEWTRON® HANDPIECE

*Class IIa medical device (GMED) - CE 0459 - Manufacturer: SATELEC® - France*

F12284



### NEWTRON® SLIM HANDPIECE

without LED for NEWTRON® P5

F12901

*Class IIa medical device (GMED) - CE 0459 - Manufacturer: SATELEC® - France*



### NEWTRON® SLIM B.LED HANDPIECE

with blue LED ring  
with white LED ring  
For NEWTRON® P5 B.LED and NEWTRON® P5 XS B.LED (Bluetooth)

F12900

F12905

*Class IIa medical device (GMED) - CE 0459 - Manufacturer: SATELEC® - France*



### NEWTRON® SLIM B.LED BLUE LED RING

F62201



### NEWTRON® SLIM B.LED WHITE LED RING

F12915



### HANDPIECE HOLDER

silicone

E60108



### NOSE FOR NEWTRON® SLIM AND NEWTRON® SLIM B.LED HANDPIECES

E12904

# ULTRASONICS

Range IV  
Accessories

## CORDS



### NEWTRON® HANDPIECE CORD

non-disconnectable for NEWTRON® Booster

X00244



### NEWTRON® SLIM HANDPIECE CORD

non-disconnectable for NEWTRON® Booster

X00227



### NEWTRON® SLIM HANDPIECE CORD

non-disconnectable for NEWTRON® P5

X00228



### NEWTRON® SLIM B.LED HANDPIECE CORD

non-disconnectable for NEWTRON® P5 B.LED and NEWTRON® P5XS B.LED (Bluetooth)

X00226

## FOOTSWITCHES



### NON-DISCONNECTABLE FOOTSWITCH

For NEWTRON® Booster

F00028



### NON-DISCONNECTABLE FOOTSWITCH

For NEWTRON® P5, NEWTRON® P5 B.LED and NEWTRON® P5XS B.LED (Bluetooth)

F00061

## DENTAL PLAQUE DISCLOSER



### DENTAL PLAQUE DISCLOSER

F.L.A.G.™ FOR B.LED 5 x 1.5ml

F62200



### DENTAL PLAQUE DISCLOSER

F.L.A.G.™ FOR B.LED 100ml

F62203

## IRRIGATION



300ml TANK

F62004



500ml TANK

F62005

## IPHONE HOLDER



### IPHONE 5 HOLDER

For NEWTRON® P5XS B.LED (Bluetooth)

F62024



# ULTRASONICS

Range III  
Accessories

**RANGE III:** P5 Newtron®, P5 Newtron® LED, P5 Newtron® XS, P5 Newtron® XS LED, P-Max Newtron® XS and Prophy Max™



## HANDPIECES



**IMPORTANT**

Handpieces compatible with all ACTEON® Equipment Dental Tips (with color coded ring: Color Coding System™)



**NEWTRON® HANDPIECE**

without LED, autoclavable, light grey/dark grey For P5 NEWTRON®, P5 NEWTRON® XS AND PROPHY MAX™

**F12281**

*Class IIa medical device (GMED) - CE 0459 - Manufacturer: SATELEC® - France*



**NOSE FOR NEWTRON® HANDPIECE**

*Class IIa medical device (GMED) - CE 0459 - Manufacturer: SATELEC® - France*

**F12284**



**NEWTRON® LED HANDPIECE**

autoclavable for P-MAX NEWTRON® XS, P5 NEWTRON® LED AND P5 NEWTRON® XS LED

**F12609**

*Class IIa medical device (GMED) - CE 0459 - Manufacturer: SATELEC® - France*



**NOSE FOR NEWTRON® LED HANDPIECE**

**E12681**



**METAL NOSE FOR NEWTRON® LED HANDPIECE**

**X12675**



**LIGHT RING**

For NEWTRON® LED handpiece

**F12605**

## FOOTSWITCH



**NON-DISCONNECTABLE FOOTSWITCH**

For P5 NEWTRON®, P5 NEWTRON® LED, P5 NEWTRON® XS, P5 NEWTRON® XS LED

**F00061**

# ULTRASONICS

Range III  
Accessories

## CORDS



**WHITE HANDPIECE CORD**

For P5 NEWTRON®

**F00223**



**WHITE HANDPIECE CORD**

For P5 NEWTRON® XS

**F00222**



**LED HANDPIECE CORD**

For P5 Newtron® LED or P5 Newtron® XS LED

**F00637**



**DISCONNECTABLE LED HANDPIECE CORD**

For P-Max Newtron® XS

**F00628**



**NEWTRON® HANDPIECE CORD**

white, with spray adjustment for Prophy-Max™

**F01176**

## IRRIGATION



**TANK**

with white cover

**F58525**



**STERIKIT - For P5 NEWTRON® XS**

Delivered with a support, a bracket, a pump cover, 5 clips, a Sterijoint and 3 sterile universal irrigation lines

**F58136**

*Irrigation line: Class Is medical device (GMED) - CE 0459 - Manufacturer: SATELEC® - France*

**STERIKIT LED - For P5 NEWTRON® XS LED**

Delivered with a support, a bracket, a pump cover, 5 clips, a LED Sterijoint and 3 sterile universal irrigation lines

**F58225**

*Irrigation line: Class Is medical device (GMED) - CE 0459 - Manufacturer: SATELEC® - France*



**STERIJOINT**

Adapter for NEWTRON® handpiece for Sterikit

**F58703**



**STERIJOINT LED**

Adapter for NEWTRON® LED handpiece for Sterikit LED

**F12640**



**UNIVERSAL IRRIGATION LINES STERILE x10**

single-use with integrated cassette and flow control system. For Sterikit and Sterikit LED

**F57370**

*Class Is medical device (GMED) - CE 0459 - Manufacturer: SATELEC® - France*



**PUMP CASSETTE**

**E58543**

# ULTRASONICS

Range II  
Accessories

**RANGE II:** P5 Newtron® blue, P5 Newtron® XS blue, P-Max Newtron®, P-Max Newtron® Lux, Prophy Max™ bleu and Prophy Max™ Lux



## HANDPIECES



**IMPORTANT**

Handpieces compatible with all ACTEON® Equipment  
Dental Tips (with color coded ring: Color Coding System™)



**NEWTRON® HANDPIECE**

autoclavable, light grey/dark grey  
For P5 NEWTRON®, P5 NEWTRON® XS AND PROPHY  
MAX™

**F12281**

*Class IIa medical device (GMED) - CE 0459 - Manufacturer: SATELEC® - France*



**NOSE FOR NEWTRON® HANDPIECE**

*Class IIa medical device (GMED) - CE 0459 - Manufacturer: SATELEC® - France*

**F12284**

## CART



**NEWTRON® CART**

Color: white

Two connections for water and electricity.  
Dimensions (DxWxH): 48 x 40 x 77cm  
3 glass trays: 42 x 36cm

**F03739**

# ULTRASONICS

Range II  
Accessories

## IRRIGATION



**NEWTRON® DOUBLE-LINES KIT x10**

For P-Max Newtron® (Lux) and Prophy Max™ (Lux)  
*Class I medical device - CE - Manufacturer: SATELEC® - France*

**F59752**



**NEWTRON® SINGLE-LINES KIT x10**

For P-Max Newtron® (Lux) and Prophy Max™ (Lux)  
*Class I medical device - CE - Manufacturer: SATELEC® - France*

**F59756**



**KIT OF 3 HOOPS FOR NEWTRON® CORD**

**F59761**



**NEWTRON® TANK - 450ml**

For P-Max Newtron® (Lux) and Prophy Max™ (Lux)

**E59774**



**NEWTRON® TANK CAP**

For P-Max Newtron® (Lux) and Prophy Max™ (Lux)

**E59775**

## FOOTSWITCHES



**NEWTRON® SINGLE FOOTSWITCH**

**F00054**



**NEWTRON® DOUBLE FOOTSWITCH**

**F00055**

# ULTRASONICS

Range |  
Accessories

**RANGE I:** Suprasson P5 Booster, P-Max, P-Max Lux, Prophy Max™, Prophy Max™ Lux and Prophy Max™ S



## HANDPIECES



**IMPORTANT**

Handpieces compatible with all ACTEON® Equipment Dental Tips (with color coded ring: Color Coding System™)



**NEWTRON® HANDPIECE**

autoclavable, light grey/dark grey

**F12281**

*Class IIa medical device (GMED) - CE 0459 - Manufacturer: SATELEC® - France*



**SELF-ADHESIVE HOLDER**

For light grey Suprasson handpiece

**F00404**



**BULB FOR LIGHT HANDPIECE CORD + 2 O'RINGS**

**F00412**



**3 GASKET O'RINGS + TOOL**

**F12304**

## CORDS



**LIGHT GREY SUPRASSON HANDPIECE CORD**

**F00195**



**LIGHT GREY SUPRASSON LUX HANDPIECE CORD**

**F00600**

## CART



**COCOON CART**

Color: white

Two connections for water and electricity  
Dimensions (DxWxH) : 45 x 40 x 80cm  
3 trays: 40 x 30cm

**F24417**

# ULTRASONICS

Range |  
Accessories

## IRRIGATION



**STERIJOINT**

**F58703**



**UNIVERSAL IRRIGATION LINES STERILE x10**  
single-use with integrated cassette and flow control system

**F57370**

*Class Is medical device (GMED) - CE 0459 - Manufacturer: SATELEC® - France*



**5 PLASTIC CAPS KIT**

for universal irrigation line

**F57375**



**BRACKET**

**X34510**



**STOPPERS KIT x10**  
for irrigation bottle

**F58790**



**AUTOCCLAVABLE IRRIGATION BOTTLE (glass)**

**E58795**



**AUTOCCLAVABLE IRRIGATION BOTTLE**  
with grey cap

**F58792**



**GREY CAP**

**F58794**



**HANGER**

for irrigation bottle

**E58791**



**STERILSTATIC IRRIGATION KIT**

Delivered with a pump motor, a holder, 3 universal irrigation lines, 5 clips, 3 hanger for bottle, 3 stoppers, a bracket and a bottle with grey cap

**F58704**

*Irrigation line: Class Is medical device (GMED) - CE 0459 - Manufacturer: SATELEC® - France*

## FOOTSWITCH



**SINGLE FOOTSWITCH**

**F00045**

## MISCELLANEOUS



**STEEL WATER FILTER 60M COMPLETE**

**F10386**

**WATER FILTER 60M CARTRIDGE + O'RING**









**F10389**

# ULTRASONICS

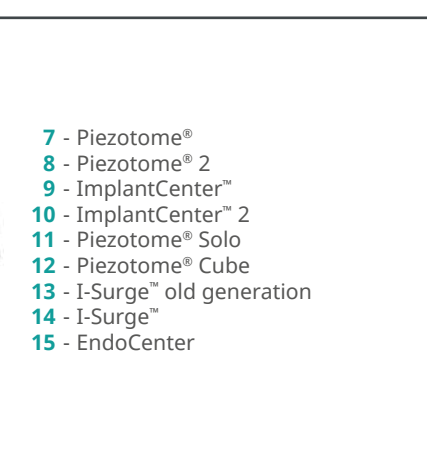
## Overview of Irrigation Lines

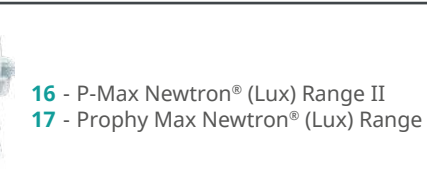
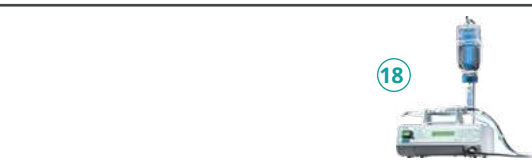
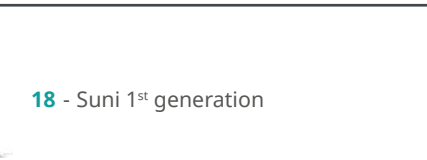
# ULTRASONICS

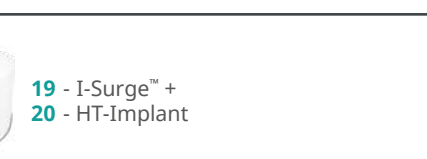
## Overview of Irrigation Lines

DEVICES	Corresponding lines	Designation	REF.
 <p>1 - Suprasson P-Max (Lux) Assortiment I                  2 - Prophy Max™ (Lux) Assortiment I                  3 - P5 Newtron® XS (LED) + Sterikit                  4 - Suni 2<sup>nd</sup> generation                  5 - Suni Max                  6 - Trans'care Max</p>		<p><b>UNIVERSAL IRRIGATION LINES STERILE x10</b>                      single-use with integrated cassette and flow control system  <i>Class Is medical device (GMED) - CE 0459 - Manufacturer: SATELEC® - France</i></p>	<p><b>F57370</b></p>
 <p>7 - Piezotome®                  8 - Piezotome® 2                  9 - ImplantCenter™                  10 - ImplantCenter™ 2                  11 - Piezotome® Solo                  12 - Piezotome® Cube                  13 - I-Surge™ old generation                  14 - I-Surge™                  15 - EndoCenter</p>		<p><b>AUTOCLAVABLE IRRIGATION LINE x1</b>                      + 10 sterile perforators  <i>Irrigation line: Class I medical device (GMED) - CE</i>  <i>Perforators: Class Is medical devices (GMED) - CE 0459</i>  <i>Manufacturer: SATELEC® - France</i></p>	<p><b>F57374</b></p>
 <p>16 - P-Max Newtron® (Lux) Range II                  17 - Prophy Max Newtron® (Lux) Range II</p>		<p><b>AUTOCLAVABLE IRRIGATION LINE x1</b>  <i>Class I medical device (GMED) - CE - Manufacturer: SATELEC® - France</i></p>	<p><b>E57374</b></p>
 <p>13 - I-Surge™ old generation                  14 - I-Surge™                  15 - EndoCenter</p>		<p><b>DISPOSABLE STERILE PERFORATORS x10</b>  <i>Class Is medical devices (GMED) - CE 0459 - Manufacturer: SATELEC® - France</i></p>	<p><b>F57372</b></p>
 <p>16 - P-Max Newtron® (Lux) Range II                  17 - Prophy Max Newtron® (Lux) Range II</p>		<p><b>NEWTRON® DOUBLE-LINES KIT x10</b>  <i>Class I medical device (GMED) - CE - Manufacturer: SATELEC® - France</i></p>	<p><b>F59752</b></p>
 <p>16 - P-Max Newtron® (Lux) Range II                  17 - Prophy Max Newtron® (Lux) Range II</p>		<p><b>NEWTRON® SINGLE-LINES KIT x10</b>  <i>Class I medical device (GMED) - CE - Manufacturer: SATELEC® - France</i></p>	<p><b>F59756</b></p>
<p>18 - Suni 1<sup>st</sup> generation</p>		<p><b>SUNI IRRIGATION LINES KIT x5</b>  <i>Class Is medical device (GMED) - CE 0459 - Manufacturer: SATELEC® - France</i></p>	<p><b>F34700</b></p>
<p>18 - Suni 1<sup>st</sup> generation</p>		<p><b>SUNI IRRIGATION LINES KIT x10</b>  <i>Class Is medical device (GMED) - CE 0459 - Manufacturer: SATELEC® - France</i></p>	<p><b>F34702</b></p>
<p>19 - I-Surge™ +                  20 - HT-Implant</p>		<p><b>IRRIGATION LINES x10</b>  <i>Class I medical device (GMED) - CE - Manufacturer: SATELEC® - France</i></p>	<p><b>F28750</b></p>

## POLISHERS

[www.acteongroup.com](http://www.acteongroup.com)

Equipment  
YouTube Channel



AIR-N-GO® easy  
brochure

<b>Polishers.....</b>	
AIR-N-GO® easy .....	126
AIR-N-GO® 1 <sup>st</sup> Generation Accessories .....	128
ProphyMax™ .....	130
AirMax.....	130
Powders.....	132





# POLISHERS

AIR-N-GO® easy

## AIR N GO EASY



### AIR-N-GO® easy

The new generation of dual purpose air polisher: Supra and Perio

- AIR-N-GO® easy with KaVo\* adapter
- AIR-N-GO® easy with Sirona\* adapter
- AIR-N-GO® easy with W&H\* adapter
- AIR-N-GO® easy with Bien-Air\* adapter
- AIR-N-GO® easy with Midwest\* adapter

- F10100**
- F10101**
- F10102**
- F10103**
- F10105**

Delivered with a convertible AIR-N-GO® easy handpiece, a Supra nozzle, 1 intro kit of 20g bags of "CLASSIC" powders, 1 AIR-N-GO® easy maintenance kit (replacement o'rings, syringe of silicone grease with brushes, cannula, cleaning drill)

*Class IIa medical device (GMED) - CE 0459 - Manufacturer: SATELEC® - France*



\*KaVo, Sirona, W&H, Bien-Air and Midwest are registered trademarks

# POLISHERS

AIR-N-GO® easy  
Accessories



### AIR-N-GO® EASY PERIO KIT

Turns your handpiece into a Perio system to treat periodontal disease (tooth & implants) on pockets from 3 to 8mm.  
Delivered with a AIR-N-GO® easy nozzle and a bottle of AIR-N-GO® PERIO glycine powder  
*Class IIa medical devices (GMED) - CE 0459 - Manufacturer: SATELEC® - France*

**F10120**



### AIR-N-GO® SUPRA NOZZLE

For all prophylaxis supra-gingival treatments

**F10125**



### AIR-N-GO® PERIO EASY NOZZLE

Turns your handpiece into a Perio system to treat non surgical periodontal disease (tooth & implants) in pockets from 3 to 8mm

**F10126**



### AIR-N-GO® PERIO NOZZLE

Turns your handpiece into a Perio system to treat non surgical periodontal disease (tooth & implants) in pockets from 3 to 8mm

**F10127**



### AIR-N-GO® PERIO MAINTENANCE NOZZLE

Turns your handpiece into a system adapted for periodontal maintenance in pockets until 4mm

**F10128**



### AIR-N-GO® EASY MAINTENANCE KIT

**F10121**



# POLISHERS

AIR-N-GO®  
Accessories

## AIR-N-GO® ACCESSORIES - 1<sup>ST</sup> GENERATION



AIR-N-GO® SUPRA NOZZLE

F10125



AIR-N-GO® PERIO NOZZLE

F10127



AIR-N-GO® SUPRA TANK

F10213



AIR-N-GO® PERIO TANK

F10216



AIR-N-GO® SUPPORT + 3 BLUE TANKS

F10209



Ø0.5mm AIR-N-GO® SUPRA PROBE

F10207



Ø1mm AIR-N-GO® SUPRA PROBE

F10208



AIR-N-GO® PERIO PROBE

F10206



AIR-N-GO® O'RINGS KIT

F10205

# POLISHERS

AIR-N-GO®  
Adapters

## AIR-N-GO® ADAPTERS



KAVO\* ADAPTER

F10240



SIRONA\* ADAPTER

F10241



W&H\* ADAPTER

F10242



BIEN-AIR\* ADAPTER

F10243



MIDWEST\* ADAPTER

F10245

For more information, please consult our website



[www.acteongroup.com/en/products/equipment](http://www.acteongroup.com/en/products/equipment)

\*KaVo, Sirona, W&H, Bien-Air and Midwest are registered trademarks

# POLISHERS

Prophy Max™ and Air Max

## prophy M ax



### PROPHY MAX™

Combinated device with ultrasonics and airpolisher

F11610

Delivered with a ProphyPen handpiece with 135° titanium nozzle, an autoclavable universal wrench, a bottle of mint powder (250g) and a bottle of lemon powder (250g), an autoclavable Newtron® handpiece, a double footswitch

*Class IIa medical device (GMED) - CE 0459 - Manufacturer: SATELEC® - France*

#### IMPORTANT

You will find all the information about ultrasonics accessories (tips, handpieces, etc) on pages 92 to 108.

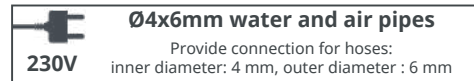

## air M ax



### AIR MAX

Supra-gingival airpolisher

F11400

Delivered with a ProphyPen handpiece with 135° titanium nozzle, an autoclavable universal wrench, a bottle of mint powder (250g) and a bottle of lemon powder (250g)

*Class IIa medical device (GMED) - CE 0459 - Manufacturer: SATELEC® - France*

# POLISHERS

Prophy Max™ and Air Max Accessories



#### BLUE PROPHYPEN

Disconnectable polisher handpiece (bayonet)  
Delivered with a 135° titanium nozzle and an autoclavable universal wrench

F10554

*Class IIa medical device (GMED) - CE 0459 - Manufacturer: SATELEC® - France*



#### WHITE PROPHYPEN

Disconnectable polisher handpiece (bayonet)  
Delivered with a 135° titanium nozzle and an autoclavable universal wrench

F10557

*Class IIa medical device (GMED) - CE 0459 - Manufacturer: SATELEC® - France*



#### TITANIUM NOZZLE 135° Ø0.7 mm

F10555



#### PROBE Ø0.7mm

E96221



#### PROBE Ø1mm

F10208



#### MULTIFUNCTIONS DOUBLE FOOTSWITCH

F00055



#### 2 PROPHYPEN O'RINGS + 1 NOZZLE O'RING KIT

F10374



#### 4 O'RINGS KIT FOR PROPHYPEN HANDPIECE CORD

F10375

# POLISHERS

Powders

## POWDER - BOTTLES



**AIR-N-GO® "CLASSIC" POWDER**  
4 bottles (250g)

- Peppermint **F10250**
- Lemon **F10251**
- Raspberry **F10252**
- Cola **F10253**
- Neutral **F10254**



**4 FLAVORS AIR-N-GO® "CLASSIC" POWDER**  
4 bottles (250g) **F10255**



**AIR-N-GO® "PERIO" POWDER**  
3 bottles (160g) **F10270**

## POWDER - BOTTLES



**AIR-N-GO® "CLASSIC" POWDER**  
50 sticks (50g)

- Peppermint **F10256**
- Lemon **F10257**
- Raspberry **F10258**
- Cola **F10259**
- Neutral **F10260**

# POLISHERS

Powders





## POLYMERIZATION

[www.acteongroup.com](http://www.acteongroup.com)

Equipment  
YouTube Channel



MiniLED™ brochure

<b>Polymerization .....</b>	
MiniLED™ Supercharged .....	136
MiniLED™ Ortho 2 .....	137
MiniLED™ Standard.....	138
MiniLED™ Active .....	139
MiniLED™ Autofocus 2 Accessories.....	140
MiniLED™ Autofocus Accessories.....	141



# POLYMERIZATION

Curing Light  
MiniLED™ Supercharged

**MINILED**  
— SUPERCHARGED

**Wavelength: 420 - 480 nm**  
**Power: 2000mW/cm<sup>2</sup>**  
**Li-Ion battery - Handpieces: anodized aluminium**

Delivered with a handpiece, a battery, a battery charger, a power supply + 4 plugs, a Ø7.5mm opalescent light guide and light shield

*Class I medical devices - CE - Manufacturer: SATELEC® - France*



F05214

## MINILED™ SUPERCHARGED - ACCESSORIES

### MINILED™ SUPERCHARGED HANDPIECE

*Class I medical device - CE - Manufacturer: SATELEC® - France*

F05217



### CHARGER

F02917



### TITANIUM BATTERY

F05211



### UNIVERSAL POWER SUPPLY

F05216



### OVAL LIGHT SHIELD

F05407



### OPALESCENT LIGHT GUIDE Ø7.5mm

F02648



### OPALESCENT LIGHT GUIDE Ø5.5mm

F02652



### AUTOCCLAVABLE CAPS Ø7.5mm x5

F61507



### AUTOCCLAVABLE CAPS Ø5.5mm x5

F61505



### AUTOCCLAVABLE CAPS Ø7.5mm x5 AUTOCCLAVABLE CAPS Ø5.5mm x5

F61515

# POLYMERIZATION

Curing Light  
MiniLED™ Ortho 2

**MINILED**  
— ORTHO 2

**Wavelength: 420 - 480 nm**  
**Power: 3000mW/cm<sup>2</sup>**  
**Li-Ion battery - Handpieces: anodized aluminium**

Delivered with a handpiece, a Ø5.5mm opalescent guide, a power supply + 4 plugs, a battery, a battery charger and an oval light shield

*Class I medical devices - CE - Manufacturer: SATELEC® - France*



F05220

## MINILED™ ORTHO 2 - ACCESSORIES

### MINILED™ ORTHO 2 HANDPIECE

*Class I medical device - CE - Manufacturer: SATELEC® - France*

F05219



### CHARGER

F02917



### TITANIUM BATTERY

F05211



### UNIVERSAL POWER SUPPLY

F05216



### OVAL LIGHT SHIELD

F05407



### OPALESCENT LIGHT GUIDE Ø7.5mm

F02648



### OPALESCENT LIGHT GUIDE Ø5.5mm

F02652



### AUTOCCLAVABLE CAPS Ø7.5mm x5

F61507



### AUTOCCLAVABLE CAPS Ø5.5mm x5

F61505



### AUTOCCLAVABLE CAPS Ø7.5mm x5 AUTOCCLAVABLE CAPS Ø5.5mm x5

F61515

# POLYMERIZATION

Curing Light  
MiniLED™ Standard

**MINILED**  
STANDARD

**Wavelength: 420 - 480 nm**  
**Power: 1250mW/cm<sup>2</sup>**  
**Li-Ion battery - Handpieces: anodized aluminium**

Delivered with a Mini LED handpiece, a battery, a battery charger, a power supply cord with european plug, a Ø7.5mm opalescent guide and an oval light shield

*Class I medical devices - CE - Manufacturer: SATELEC® - France*

**F02507**



## MINILED™ STANDARD - ACCESSORIES

### MINILED™ HANDPIECE

*Class I medical device - CE - Manufacturer: SATELEC® - France*

**F02530**

### CHARGER

**F02510**

### TITANIUM BATTERY

**F02520**

### EUROPEAN POWER SUPPLY

**F02543**

### OVAL LIGHT SHIELD

**F02555**



### OPALESCENT LIGHT GUIDE Ø7.5mm

**F02648**



### OPALESCENT LIGHT GUIDE Ø5.5mm

**F02652**



### AUTOCCLAVABLE CAPS Ø7.5mm x5

**F61507**



### AUTOCCLAVABLE CAPS Ø5.5mm x5

**F61505**



### AUTOCCLAVABLE CAPS Ø7.5mm x5 AUTOCCLAVABLE CAPS Ø5.5mm x5

**F61515**

# POLYMERIZATION

Curing Light  
MiniLED™ Active

**MINILED**  
ACTIVE

**Wavelength: 420 - 480 nm**  
**Power: 1492mW/cm<sup>2</sup>**  
**Li-Ion battery - Handpieces: anodized aluminium**

Delivered with a Mini LED handpiece, an universal power supply cord, a Ø7.5mm opalescent guide and an oval light shield

*Class I medical devices - CE - Manufacturer: SATELEC® - France*

**F05100**



## MINILED™ ACTIVE - ACCESSORIES



### MINILED™ ACTIVE HANDPIECE

*Class I medical device - CE - Manufacturer: SATELEC® - France*

**F05105**



### UNIVERSAL POWER SUPPLY

**F05120**



### OVAL LIGHT SHIELD

**F05407**



### OPALESCENT LIGHT GUIDE Ø7.5mm

**F05121**





# POLYMERIZATION

Curing Light  
Former Generation Accessories





## MINILED™ AUTOFOCUS 2 - ACCESSORIES

	<b>CHARGER</b>	<b>F02917</b>
	<b>TITANIUM BATTERY</b>	<b>F05211</b>
	<b>UNIVERSAL POWER SUPPLY</b>	<b>F05216</b>
	<b>OVAL LIGHT SHIELD</b>	<b>F05407</b>
	<b>OPALESCENT LIGHT GUIDE Ø7.5mm</b>	<b>F02647</b>
	<b>OPALESCENT LIGHT GUIDE Ø5.5mm</b>	<b>F02653</b>
	<b>AUTOCLAVABLE CAPS Ø7.5mm x5</b>	<b>F61507</b>
	<b>AUTOCLAVABLE CAPS Ø5.5mm x5</b>	<b>F61505</b>
	<b>AUTOCLAVABLE CAPS Ø7.5mm x5 AUTOCLAVABLE CAPS Ø5.5mm x5</b>	<b>F61515</b>

# POLYMERIZATION

Curing Light  
Former Generation Accessories

## MINILED™ AUTOFOCUS - ACCESSORIES

	<b>POWER SUPPLY</b>	<b>F02940</b>
	<b>OPALESCENT LIGHT GUIDE Ø7.5mm</b>	<b>F02654</b>
	<b>BATTERY</b>	<b>F02901</b>
	<b>AUTOCLAVABLE CAPS Ø7.5mm x5</b>	<b>F61516</b>

For more information, please consult our website



[www.acteongroup.com/en/products/equipment](http://www.acteongroup.com/en/products/equipment)



## MISCELLANEOUS

[www.acteongroup.com](http://www.acteongroup.com)

 Equipment  
YouTube Channel



<b>Miscellaneous.....</b>	
Softly .....	144
Cocoon Hygienist LED Accessories .....	145
Trans'Care Accessories .....	145
EndoCenter & EndoDual Accessories .....	146
I-EndoDual Accessories .....	147
Quaz® Accessories.....	148
Vela 170 Accessories.....	149



# MISCELLANEOUS

## SOFTLY



SOFTLY  
Amalgamator

**SOFTLY**  
Pre-measured capsules amalgamator

External dimensions:  
210 x 205 x 120mm (D x W x P)  
Weight: 3.1kg

6.01.00112



For more information, please consult our website



[www.acteongroup.com/en/products/equipment](http://www.acteongroup.com/en/products/equipment)

# MISCELLANEOUS

Former Devices  
Accessories

## COCOON HYGIENIST LED - ACCESSORIES



**LIGHT MOTOR**  
Class IIa medical device (GMED) - CE 0459 - Manufacturer: SATELEC® - France

F28600



**MEDIUM GREY CORD**  
for light and IS motors

F33711

## TRANS'CARE - ACCESSORIES



**LIGHT MOTOR**  
Class IIa medical device (GMED) - CE 0459 - Manufacturer: SATELEC® - France

F28600



**LIGHT MOTOR BLACK COILED CORD**

F33713

# MISCELLANEOUS

Former Devices  
Accessories

## ENDOCENTER & ENDODUAL - ACCESSORIES



**ENDO MICROMOTOR**

*Class IIa medical device (GMED) - CE 0459 - Manufacturer: SATELEC® - France*

**F28920**



**ENDOCENTER MULTIFUNCTION FOOTSWITCH**

**F28951**



**ENDODUAL SINGLE FOOTSWITCH GREY**

**F28911**



**UNIVERSAL IRRIGATION LINES STERILE x10**  
single-use with integrated cassette and flow control system

*Class IIs medical device (GMED) - CE 0459 - Manufacturer: SATELEC® - France*

**F57370**



**AUTOCLAVABLE IRRIGATION LINE x1**  
+ 10 sterile perforators

*Irrigation line: Class I medical devices (GMED) - CE  
Perforators: Class IIs medical device (GMED) - CE 0459  
Manufacturer: SATELEC® - France*

**F57374**



**DISPOSABLE STERILE PERFORATORS x10**

*Class IIs medical device (GMED) - CE 0459 - Manufacturer: SATELEC® - France*

**F57372**



**ENDODUAL POWER SUPPLY**

**F28915**



**ENDOCENTER POWER SUPPLY**

**F28955**



**ENDOCENTER BRACKET**

**F28967**



**HANDPIECE HOLDER**  
silicone

**E60108**

# MISCELLANEOUS

Former Devices  
Accessories

## I-ENDO DUAL - ACCESSORIES



**I-ENDO DUAL MOTOR + CORD**

*Class IIa medical device (GMED) - CE 0459 - Manufacturer: SATELEC® - France*

**F28850**



**I-ENDO DUAL FOOTSWITCH**

**F28911**

# MISCELLANEOUS

Former Devices  
Accessories

## QUAZ® AUTOCLAVE - ACCESSORIES



**QUAZ® DEM 5.30**  
Demineralizer with distilled water quality sensor  
*compatible with Quaz® 5.17 & 5.24* **F03931**

**QUAZ® DEM 6.30**  
Demineralizer  
*compatible with Quaz® 6.17 & 6.24* **F03932**

**FILTER CARTRIDGE 30"**  
for Quaz® Dem 5.30 & 6.30 **F03933**

**FILTER CARTRIDGE 20"**  
for Quaz® Dem 5.20 & 6.20 **F03914**

**FILTER CARTRIDGE 10"**  
for Quaz® Dem 5.10 & 6.10 **F03919**



**QUAZ® SEALER**  
*Discontinued, available until stock runs out* **F03930**



**SEAL TEST x100** **F03937**

# MISCELLANEOUS

Former Devices  
Accessories

## QUAZ® AUTOCLAVE - ACCESSORIES



**QUAZ® PRINT**  
Barcode printer (on labels) **F03927**



**2 STICKERS ROLLS + 2 RIBBONS**  
for Quaz® print **F03928**



**PRINTER "QUAZ® PRINTER" 230V'**  
*Discontinued, available until stock runs out* **F03933**



**STERILIZATION BOX** **F03912**



**TUBE FOR AUTOMATIC FILLING** **F03910**



**TUBE FOR AUTOMATIC EMPTYING** **F03911**



**BACTERIOLOGICAL FILTER** **F03904**

## VELA 170 AUTOCLAVE - ACCESSORIES

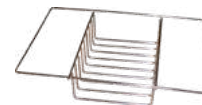

**CARRIER FOR STERILIZATION BAGS**  
for Vela 170 **E03558**



**TUBE FOR FILLING VACUUM + MALE CONNECTOR**  
for Vela 170 **E03648**



IT'S TIME  
TO BETTER  
DIAGNOSE  
AND TREAT  
LISA

ACTEON  
MANUAL  
INSTRUMENTS





MIRRORS

www.acteongroup.com

Instrumentation  
YouTube Channel



Mirrors catalog

**Mirrors.....**









- Mouth Mirrors ..... 154
- Anti-mist solution ..... 156
- Micro Mirrors ..... 157
- Mirrors Handles..... 157
- Photographic Mirrors ..... 158



# INSTRUMENTATION

## Mirrors

### PLAN MOUTH MIRRORS

Ø14mm		<b>ALU MIRROR N°0 x12</b> <b>RH MIRROR N°0 x12</b> <b>TI MIRROR N°0 x12</b> <b>PURE REFLECT® MIRROR N°0 x12</b>	<b>MP3114PH</b> <b>MP3314PH</b> <b>MP3514PH</b> <b>MP3614PH</b>
Ø16mm		<b>ALU MIRROR N°1 x12</b> <b>RH MIRROR N°1 x12</b> <b>TI MIRROR N°1 x12</b> <b>PURE REFLECT® MIRROR N°1 x12</b>	<b>MP3116PH</b> <b>MP3316PH</b> <b>MP3516PH</b> <b>MP3616PH</b>
Ø18mm		<b>ALU MIRROR N°2 x12</b> <b>RH MIRROR N°2 x12</b> <b>TI MIRROR N°2 x12</b> <b>PURE REFLECT® MIRROR N°2 x12</b>	<b>MP3118PH</b> <b>MP3318PH</b> <b>MP3518PH</b> <b>MP3618PH</b>
Ø20mm		<b>ALU MIRROR N°3 x12</b> <b>RH MIRROR N°3 x12</b> <b>TI MIRROR N°3 x12</b> <b>PURE REFLECT® MIRROR N°3 x12</b>	<b>MP3120PH</b> <b>MP3320PH</b> <b>MP3520PH</b> <b>MP3620PH</b>
Ø22mm		<b>ALU MIRROR N°4 x12</b> <b>ALU MIRROR N°4 x20</b> <b>RH MIRROR N°4 x12</b> <b>RH MIRROR N°4 x20</b> <b>TI MIRROR N°4 x12</b> <b>PURE REFLECT® MIRROR N°4 x12</b>	<b>MP3122PH</b> <b>MPV3122PH</b> <b>MP3322PH</b> <b>MPV3322PH</b> <b>MP3522PH</b> <b>MP3622PH</b>
Ø24mm		<b>ALU MIRROR N°5 x12</b> <b>ALU MIRROR N°5 x20</b> <b>RH MIRROR N°5 x12</b> <b>RH MIRROR N°5 x20</b> <b>TI MIRROR N°5 x12</b> <b>PURE REFLECT® MIRROR N°5 x12</b>	<b>MP3124PH</b> <b>MPV3124PH</b> <b>MP3324PH</b> <b>MPV3324PH</b> <b>MP3524PH</b> <b>MP3624PH</b>
Ø26mm		<b>ALU MIRROR N°6 x12</b> <b>RH MIRROR N°6 x12</b> <b>TI MIRROR N°6 x12</b> <b>PURE REFLECT® MIRROR N°6 x12</b>	<b>MP3126PH</b> <b>MP3326PH</b> <b>MP3526PH</b> <b>MP3626PH</b>
Ø28mm		<b>ALU MIRROR N°7 x1</b> <b>RH MIRROR N°7 x1</b> <b>TI MIRROR N°7 x1</b> <b>PURE REFLECT® MIRROR N°7 x1</b>	<b>MP3128PH</b> <b>MP3328PH</b> <b>MP3528PH*</b> <b>MP3628PH</b>

\*Discontinued, available until stock runs out

# INSTRUMENTATION

## Mirrors

### PLAN MOUTH MIRRORS

Ø30mm		<b>ALU MIRROR N°8 x1</b> <b>RH MIRROR N°8 x1</b> <b>TI MIRROR N°8 x1</b> <b>PURE REFLECT® MIRROR N°8 x1</b>	<b>MP3130PH</b> <b>MP3330PH</b> <b>MP3530PH</b> <b>MP3630PH</b>
Ø40mm		<b>ALU MIRROR N°9 x1</b> <b>RH MIRROR N°9 x1</b> <b>TI MIRROR N°9 x1</b> <b>PURE REFLECT® MIRROR N°9 x1</b>	<b>MP3140PH</b> <b>MP3340PH</b> <b>MP3540PH</b> <b>MP3640PH</b>
Ø50mm		<b>ALU MIRROR N°10 x1</b> <b>RH MIRROR N°10 x1</b> <b>TI MIRROR N°10 x1</b> <b>PURE REFLECT® MIRROR N°10 x1</b>	<b>MP3155PH</b> <b>MP3355PH</b> <b>MP3555PH</b> <b>MP3655PH</b>

### DOUBLE SIDED MOUTH MIRRORS

	<b>RH MIRROR N°4 x12</b> <b>RH MIRROR N°4 x6</b> <b>RH MIRROR N°5 x12</b> <b>RH MIRROR N°5 x6</b>	<b>MP7322PH</b> <b>MP7422PH</b> <b>MP7324PH</b> <b>MP7424PH</b>
	<b>TI MIRROR N°4 x12</b> <b>TI MIRROR N°4 x6</b> <b>TI MIRROR N°5 x12</b> <b>TI MIRROR N°5 x6</b>	<b>MP7522PH</b> <b>MP7622PH</b> <b>MP7524PH</b> <b>MP7624PH</b>
	<b>PURE REFLECT® MIRROR N°4 x12</b> <b>PURE REFLECT® MIRROR N°4 x6</b> <b>PURE REFLECT® MIRROR N°5 x12</b> <b>PURE REFLECT® MIRROR N°5 x6</b>	<b>MP7822PH</b> <b>MP7722PH</b> <b>MP7824PH</b> <b>MP7724PH</b>

# INSTRUMENTATION

## Mirrors

### MAGNIFYING MOUTH MIRRORS (x3.5 magnification)



ALU MIRROR N°2 x12  
 ALU MIRROR N°3 x12  
 ALU MIRROR N°4 x12  
 ALU MIRROR N°5 x12  
 ALU MIRROR N°6 x12  
 ALU MIRROR N°7 x1  
 ALU MIRROR N°8 x1  
 ALU MIRROR N°9 x1  
 ALU MIRROR N°10 x1

MP3218PH  
 MP3220PH  
 MP3222PH  
 MP3224PH  
 MP3226PH  
 MP3228PH  
 MP3230PH  
 MP3240PH  
 MP3255PH

RH MIRROR N°4 x12  
 RH MIRROR N°5 x12

MP3422PH  
 MP3424PH

### ANTI-MIST SOLUTION FOR MIRRORS



100ml

ABF

# INSTRUMENTATION

## Micro Mirrors

### MICRO MIRRORS



PURE REFLECT® MICRO MIRROR  
 Ø3 mm - round

MP3303PH



PURE REFLECT® MICRO MIRROR  
 Ø5 mm - round

MP3305PH



PURE REFLECT® MICRO MIRROR  
 7x2 mm - rectangular

MP3306RPH



PURE REFLECT® MICRO MIRROR  
 9x3 mm - rectangular

MP3310RPH



PURE REFLECT® MICRO MIRROR  
 Ø3 mm - 14.8cm - round

MP1303PH



PURE REFLECT® MICRO MIRROR  
 Ø5 mm - 14.8cm - round

MP1305PH



PURE REFLECT® MICRO MIRROR  
 7x2 mm - 14.8cm - rectangular

MP1306RPH



PURE REFLECT® MICRO MIRROR  
 9x3 mm - 14.8cm - rectangular

MP1310RPH

### MIRROR HANDLES



handleXL Style

XL STYLE MIRROR HANDLE

210.00XL



handleDesign

DESIGN MIRROR HANDLE

210.00D

# INSTRUMENTATION

Mirrors

## DOUBLE SIDED PHOTOGRAPHIC MIRRORS

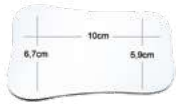

**Occlusal Surface Adult**  
TITANIUM  
CHROMIUM  
PURE REFLECT®

*MZP511.*  
*MZP512.*  
*MZP516.*

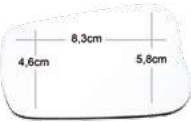

**Occlusal Surface Child**  
TITANIUM  
CHROMIUM  
PURE REFLECT®

*MZP521.*  
*MZP522.*  
*MZP526.*

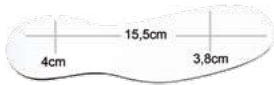

**Vestibular Surface**  
TITANIUM  
CHROMIUM  
PURE REFLECT®

*MZP531.*  
*MZP532.*  
*MZP536.*

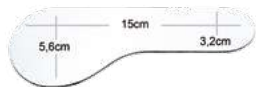

**Thin Lingual Surface**  
TITANIUM  
CHROMIUM  
PURE REFLECT®

*MZP541.*  
*MZP542.*  
*MZP546.*



**Large Lingual Surface**  
TITANIUM  
CHROMIUM  
PURE REFLECT®

*MZP551.*  
*MZP552.*  
*MZP556.*



**Lateral Shape**  
TITANIUM  
CHROMIUM  
PURE REFLECT®

*MZP561.*  
*MZP562.*  
*MZP566.*

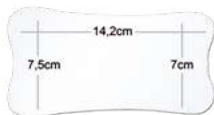

**Large Occlusal Surface**  
TITANIUM  
CHROMIUM  
PURE REFLECT®

*MZP571.*  
*MZP572.*  
*MZP576.*

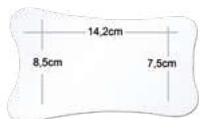

**Extra Large Occlusal Surface**  
TITANIUM  
CHROMIUM  
PURE REFLECT®

*MZP581.*  
*MZP582.*  
*MZP586.*

# INSTRUMENTATION

Mirrors

## CONTRASTORS



**CONTRASTOR N°4 SMALL STRAIGHT DESIGN**  
240x60x1.5mm

*MZP215*



**CONTRASTOR N°5 LARGE STRAIGHT DESIGN**  
240x60x1.5mm

*MZP216*



**CONTRASTOR N°3**  
73x70mm

*MZP217*



**CONTRASTOR N°1**  
84x85mm angular

*MZP218*



**CONTRASTOR N°2**  
59x70mm angular

*MZP219*

## ROTATING HOLDER FOR PHOTOGRAPHIC MIRRORS



**ROTATING HOLDER FOR PHOTOGRAPHIC MIRRORS**

*MZP214.*

## STERILIZATION TRAY



**STERILIZATION TRAY FOR PHOTOGRAPHIC MIRRORS**

for 3 photographic mirrors  
or 2 photographic mirrors + 1 handle  
(sold empty)

*233.19*



## BLISS

[www.acteongroup.com](http://www.acteongroup.com)

Instrumentation  
YouTube Channel



Bliss catalog

**Bliss Range.....**

Gracey Curettes .....	163
Sickles .....	163
Universal Curettes.....	164
Dual Ends .....	164
Diagnostics.....	164
Restoration.....	165
Periodontics.....	166
Endodontics .....	167
Mirror Handle .....	167



# INSTRUMENTATION

Bliss

## BLISS, THE NEXT GENERATION OF MANUAL INSTRUMENTS

- UNIQUE SOFT TOUCH GRIP
- EXCELLENT SHARP EDGES
- LATEST SHARPENING TECHNIQUES
- LONG LASTING SHARPNESS

*Bliss*  
by Acteon



LIGHT WEIGHT  
15g

ERGONOMIC AND COMFORTABLE HANDLE

# INSTRUMENTATION

Bliss

## GRACEY CURETTES



GRACEY 1-2

402.01SI



GRACEY 5-6

402.05SI



GRACEY 11-12

402.11SI



GRACEY 13-14

402.13SI



GRACEY 15-16

402.15SI



GRACEY 17-18

402.17SI

## SICKLES



M23

404.23SI



H6-H7

406.07SI



# INSTRUMENTATION

Bliss

## UNIVERSAL CURETTES



**BARNHART 5-6**

**408.05SI**



**COLUMBIA 4L-4R**

**405.04SI**



**COLUMBIA 13-14**

**405.13SI**



**LANGER 5-6**

**406.06SI**

## DUAL ENDS



**H5-L5**

**406.05SI**



**N128-L5**

**406.08SI**



**N128-L5 MINI**

**406.09SI**

## DIAGNOSTICS



**EXP 11-12**

**263.06SI**



**EXP 17-23**

**263.07SI**

# INSTRUMENTATION

Bliss

## RESTORATION



**EXC 36-35**

**165.01SI**



**EXC 38-37**

**165.02SI**



**EXC 91**

**165.03SI**



**BUR 125-126**

**108.14SI**



**CMS N°1**

**194.12SI**



**CMS N°2**

**194.13SI**



**CMS N°3 - L4/5.4mm**

**194.14SI**



**CMS N°4 - L4/5.6mm**

**194.15SI**



**CMS N°5 - L1.6/1.6mm**

**194.16SI**



**CMS N°6 - L1.6/1.6mm  
FOR MOLARS**

**192.05SI**

# INSTRUMENTATION

Bliss

## RESTORATION



SP20 - 20mm

246.05SI



SP25 - 25mm

246.09SI



SP42 - 42mm

246.24SI

## PERIODONTICS



UNC12-EX23 - graduated 1 to 12mm

418.06SI



CP12-EX23 - graduated 3-6-9-12mm

418.07SI



UNC15-EX23 - graduated 1 to 15mm

418.08SI



CP15-EX23 - graduated 3-6-9-12-15mm

418.09SI

# INSTRUMENTATION

Bliss

## ENDODONTICS



Ø 0.5mm

MACHTOU 1-1

419.01SI



Ø 0.6mm

MACHTOU 1-2

419.02SI



Ø 0.8mm

MACHTOU 2-3

419.03SI



Ø 1mm

MACHTOU 2-4

419.04SI

## MIRROR HANDLE



MIRROR HANDLE EU STEM  
MIRROR HANDLE CSS  
mirror sold separately\*

210.00SI  
212.00SI

Pure Reflect size S: MP4624PH (CSS) - MP3624PH (EU Stem)

Class I medical devices - CE - Manufacturer: Prodont Holliger - France



DIAGNOSTICS

[www.akteongroup.com](http://www.akteongroup.com)

Instrumentation  
YouTube Channel



Instrumentation  
catalog

**Diagnostics** .....

Examination & Care Sets .....	170
Tweezers.....	171
Probes.....	172



# INSTRUMENTATION

Diagnostics

## 3 INSTRUMENTS EXAMINATION SET

handleXL Style



**EXAMINATION SET XL STYLE HANDLE**  
1 XL Style handle (210.00XL) + n°4 mirror (x12 - MP3622PH), 1 probe (262.20XL), 1 COLLEGE tweezer (220.02S.)

500.00XL.

handleDesign



**EXAMINATION SET DESIGN HANDLE**  
1 Design handle (210.00D) + n°4 mirror (x12 - MP3622PH), 1 probe (262.20D), 1 COLLEGE tweezer (220.02.)

500.00D.

## 4 INSTRUMENTS CARE SET

handleXL Style



**CARE SET XL STYLE HANDLE**  
1 XL Style handle (210.00XL) + n°4 mirror (x12 - MP3622PH), 1 H.E.I. n°1 spatula (193.01XL), 1 probe (262.09XL), 1 COLLEGE tweezer (220.02S.)

501.00XL.

handleDesign



**EXAMINATION SET DESIGN HANDLE**  
1 Design handle (210.00D) + n°4 mirror (x12 - MP3622PH), 1 H.E.I. n°1 spatula (193.01D), 1 probe (262.09D), 1 COLLEGE tweezer (220.02.)

501.00D.

# INSTRUMENTATION

Diagnostics

## TWEEZERS



**COLLEGE TWEEZERS - 15cm**  
serrated

219.02



**COLLEGE TWEEZERS - 15 cm**  
smooth

220.02.



**COLLEGE TWEEZERS - 15 cm**  
satiny

220.02S.



**PERRY TWEEZERS N°2 - 13cm**  
serrated jaws

222.02



**PERRY TWEEZERS N°3 - 13cm**  
serrated jaws

222.03



**MERIAM TWEEZERS - 16cm**

227.00

Other models available. To discover all the range, please consult

Catalog

Website

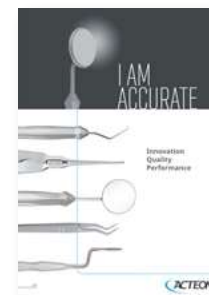

Instrumentation catalog  
REF. 8000.01



[www.actedgroup.com/en/products/  
manual-instrumentation](http://www.actedgroup.com/en/products/manual-instrumentation)











# INSTRUMENTATION

Diagnostics

## ONE-SIDED PROBES

handleXL Style handleDesign

	<b>SIMPLE PROBE N°6</b>	<b>262.06XL</b>	<b>262.06D</b>
	<b>SIMPLE PROBE N°7</b>	<b>262.07XL</b>	<b>262.07D</b>
	<b>SIMPLE PROBE N°8</b>	<b>262.08XL</b>	<b>262.08D</b>
	<b>SIMPLE PROBE N°9</b>	<b>262.09XL</b>	<b>262.09D</b>
	<b>SIMPLE PROBE N°17</b>	<b>262.17XL</b>	<b>262.17D</b>
	<b>SIMPLE PROBE N°20</b>	<b>262.20XL</b>	<b>262.20D</b>
	<b>SIMPLE PROBE N°23</b>	<b>262.23XL</b>	<b>262.23D</b>
	<b>SIMPLE PROBE RHEIN N°3</b>	<b>266.03XL</b>	<b>266.03D</b>

## SPECIAL ONE-SIDED PROBES

handleXL Style handleDesign

	<b>SIMPLE PROBE N°1</b>	<b>262.01XL</b>	<b>262.01D</b>
	<b>SIMPLE PROBE N°5</b>	<b>262.05XL</b>	<b>262.05D</b>
	<b>SIMPLE PROBE N°19</b>	<b>262.19XL</b>	
	<b>SIMPLE PROBE FINE END N°24</b>	<b>262.24XL</b>	<b>262.24D</b>

The instruments presented above correspond to the XL Style handle version

Class I medical devices - CE - Manufacturer: Prodont Holliger - France

# INSTRUMENTATION

Diagnostics

## ONE-SIDED PROBES

handleXL Style handleDesign

	<b>DOUBLE PROBE N°16</b>	<b>263.16XL</b>	
	<b>DOUBLE PROBE N°23</b>	<b>263.23XL</b>	
	<b>DOUBLE PROBE N°5</b>	<b>263.05XL</b>	<b>263.05D</b>
	<b>DOUBLE PROBE N°6</b>	<b>263.06XL</b>	<b>263.06D</b>
	<b>DOUBLE PROBE N°7</b>	<b>263.07XL</b>	<b>263.07D</b>
	<b>BRIAULT PROBE B11</b>	<b>268.02XL</b>	<b>268.02D</b>
	<b>WESTON PROBE W12</b>	<b>269.02XL</b>	<b>269.02D</b>

The instruments presented above correspond to the XL Style handle version

Class I medical devices - CE - Manufacturer: Prodont Holliger - France

RESTORATION

www.acteongroup.com

Instrumentation  
YouTube Channel

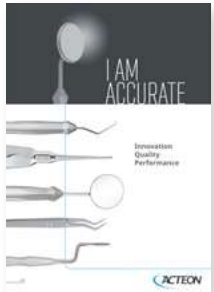

Instrumentation  
catalog

**Restoration .....**

- Sealing Spatulas & Modelling ..... 176
- Amalgam Instruments..... 177
- GingiProtect® ..... 179
- Gingival Retraction Instrument..... 180
- Pluggers ..... 180
- Burnishers..... 180
- Excavators ..... 181
- Cement Spatulas ..... 181













# INSTRUMENTATION

Restoration

## SEALING SPATULAS AND MODELLING

handleXL Style handleDesign

	<b>WHITE (W.H.E.) N°4</b>	<b>204.04XL</b>	<b>204.04D</b>
	<b>WILLIAM DIRIGO (W.D.) N°4</b>	<b>205.04XL</b>	<b>205.04D</b>
	<b>SPECIAL (L.S.P.) N°5 ZRN*</b>	<b>208.05TXL</b>	<b>208.05TD</b>
	<b>SPECIAL (L.S.P.) N°6</b>	<b>208.06XL</b>	<b>208.06D</b>
	<b>PROXIMAL SURFACE COMPOSITE</b>	<b>199.00XL</b>	<b>199.00D</b>
	<b>HEIDEMANN (H.E.I.) N°1</b>	<b>193.01XL</b>	<b>193.01D</b>
	<b>HEIDEMANN (H.E.I.) N°2</b>	<b>193.02XL</b>	<b>193.02D</b>
	<b>HEIDEMANN (H.E.I.) N°1 ZRN*</b>	<b>193.01TXL</b>	<b>193.01TD</b>
	<b>HEIDEMANN (H.E.I.) N°2 ZRN*</b>	<b>193.02TXL</b>	<b>193.02TD</b>

\* Zirconium Nitride Coated

The instruments presented above correspond to the XL Style handle version





Class I medical devices - CE - Manufacturer: Prodont Holliger - France

# INSTRUMENTATION

Restoration

## AMALGAM DOUBLE INSTRUMENTS

handleXL Style handleDesign

	<b>BOYD WALLIS (B.W.) N°4</b>	<b>206.04XL</b>	<b>206.04D</b>
	<b>WESCOTT N°22</b>	<b>201.22XL</b>	<b>201.22D</b>
	<b>JLM 6 ED</b>	<b>259.06XL</b>	<b>259.06D</b>
	<b>F.O.C SERRATED DOUBLE PLUGGERS</b>	<b>173.01XL</b>	<b>173.01D</b>
	<b>F.O.C SMOOTH DOUBLE PLUGGERS</b>	<b>173.04XL</b>	<b>173.04D</b>

Other models available. To discover all the range, please consult

Catalog

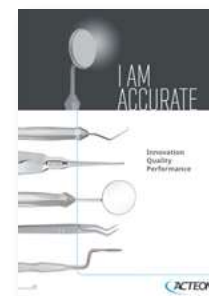

Instrumentation catalog  
REF. 8000.01

Website



[www.aceongroup.com/en/products/manual-instrumentation](http://www.aceongroup.com/en/products/manual-instrumentation)







The instruments presented above correspond to the XL Style handle version

Class I medical devices - CE - Manufacturer: Prodont Holliger - France



# INSTRUMENTATION

Restoration

## DOUBLE PLUGGERS AND COMPOSITE INSTRUMENTS

	handleXL Style	handleDesign	
<b>ROMEROWSKI</b>			<b>404.04XL</b>
			
<b>HOLLEBACK N°3</b>			<b>191.03XL 191.03D</b>
			
<b>HOLLEBACK 1/2-3</b>			<b>191.04XL 191.04D</b>
			
<b>UWD / DISCOÏD CLEOÏD</b>			<b>186.05D</b>

## SIMPLE PLUGGER AND COMPOSITE INSTRUMENTS

	handleXL Style	handleDesign	
<b>CLEOÏD N°89</b>			<b>186.89XL 186.89D</b>
			
<b>CLEOÏD N°93</b>			<b>186.93XL</b>

Other models available. To discover all the range, please consult

Catalog

Website



Instrumentation catalog  
REF. 8000.01

[www.acteongroup.com/en/products/  
manual-instrumentation](http://www.acteongroup.com/en/products/manual-instrumentation)

The instruments presented above correspond to the XL Style handle version except 185.06D (Design handle)

Class I medical devices - CE - Manufacturer: Prodont Holliger - France

# INSTRUMENTATION

Restoration

## GINGIPROTECT®

handleDesign

### Gingival Retraction Instruments

- Effective protection and retraction of the marginal gum
- Direct and precise access to the margins



	<b>GINGIPROTECT® DOUBLE INSTRUMENT</b> *L 3.2mm	<b>261GPR2</b>
	<b>GINGIPROTECT® DOUBLE INSTRUMENT</b> *L 3.7mm	<b>261GPR3</b>
	<b>GINGIPROTECT® DOUBLE INSTRUMENT</b> *L 4.3mm	<b>261GPR4</b>

Class I medical devices - CE - Manufacturer: Prodont Holliger - France

# INSTRUMENTATION

Restoration

## GINGIVAL RETRACTION THREAD INSTRUMENTS

	handleXL Style	handleDesign
<b>DOUBLE INSTRUMENT</b> for gingival retraction with saw edge	<b>154.02XL</b>	<b>154.02D</b>
		
<b>DOUBLE INSTRUMENT</b> for gingival retraction without saw edge	<b>154.03XL</b>	<b>154.03D</b>

## TEMPORARY BANDAGES, CROWNS AND BRIDGES INSTRUMENTS

	handleXL Style	handleDesign
	<b>170.00XL</b>	<b>170.00D</b>

## TEMPORARY CAVITY BOTTOM INSTRUMENTS

	handleXL Style	handleDesign
	<b>170.01XL</b>	<b>170.01D</b>

## DOUBLE BURNISHERS

	handleXL Style	handleDesign
<b>DOUBLE BURNISHERS N°15</b>	<b>108.15XL</b>	<b>108.15D</b>

## SIMPLE BURNISHERS



	handleXL Style	handleDesign
<b>SIMPLE BURNISHERS N°28</b>	<b>106.28XL</b>	<b>106.28D</b>

The instruments presented above correspond to the XL Style handle version  
Class I medical devices - CE - Manufacturer: Prodont Holliger - France





# INSTRUMENTATION

Restoration

## EXCAVATORS

	handleXL Style	handleDesign
<b>DARBY-PERRY DOUBLE EXCAVATOR</b>	<b>162.00XL</b>	<b>162.00D</b>
		
<b>WHITE D.E.E. DOUBLE EXCAVATOR</b>	<b>163.05XL</b>	<b>163.05D</b>
		
<b>ASH DOUBLE EXCAVATOR</b>	<b>164.16XL</b>	<b>164.16D</b>

## SIMPLE CEMENT SPATULAS

	handleXL Style	handleDesign
<b>SIMPLE CEMENT SPATULA N°11</b>	<b>246.11XL</b>	<b>246.11D</b>
		
<b>SIMPLE CEMENT SPATULA N°18</b> ultra flexible	<b>246.18XL</b>	<b>246.18D</b>
		
<b>SIMPLE CEMENT SPATULA N°24</b>	<b>248.24XL</b>	<b>248.24D</b>
		
<b>SIMPLE CEMENT SPATULA N°26</b>	<b>250.36XL</b>	<b>250.36D</b>

## DOUBLE CEMENT SPATULAS

	handleXL Style	handleDesign
<b>DOUBLE CEMENT SPATULA N°1</b>	<b>252.01XL</b>	<b>252.01D</b>

Other models available. To discover all the range, please consult

Catalog

Website



Instrumentation catalog  
REF. 8000.01

[www.acteongroup.com/en/products/  
manual-instrumentation](http://www.acteongroup.com/en/products/manual-instrumentation)

The instruments presented above correspond to the XL Style handle version  
Class I medical devices - CE - Manufacturer: Prodont Holliger - France

## PROSTHESIS

[www.acteongroup.com](http://www.acteongroup.com)

Instrumentation  
YouTube Channel

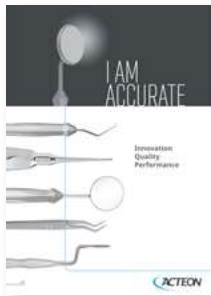

Instrumentation  
catalog

**Prosthesis** .....

Impression Trays .....	184
Prosthesis Instruments .....	186



# INSTRUMENTATION

Prosthesis  
Impression Tray

## IMPRESSION TRAYS N°1

Thin straight edges

UPPER

LOWER

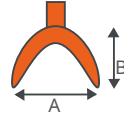
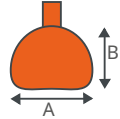

STANDARD SIZE 1 61x47mm	<b>3040.U1</b>	STANDARD SIZE 1 55x47mm	<b>3040.L1</b>
STANDARD SIZE 2 64x51mm	<b>3040.U2</b>	STANDARD SIZE 2 60x49mm	<b>3040.L2</b>
STANDARD SIZE 3 66x53mm	<b>3040.U3</b>	STANDARD SIZE 3 72x54mm	<b>3040.L3</b>
STANDARD SIZE 4 69x57mm	<b>3040.U4</b>	STANDARD SIZE 4 75x57mm	<b>3040.L4</b>
STANDARD SIZE 5 71x60mm	<b>3040.U5</b>	STANDARD SIZE 5 76x59mm	<b>3040.L5</b>
STANDARD SIZE 6 73x62mm	<b>3040.U6</b>	STANDARD SIZE 6 78x61mm	<b>3040.L6</b>

## IMPRESSION TRAYS N°2

Retentive edges

UPPER

LOWER

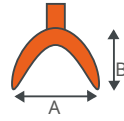
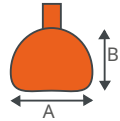

STANDARD SIZE 1 61x47mm	<b>3041.U1</b>	STANDARD SIZE 1 55x47mm	<b>3041.L1</b>
STANDARD SIZE 2 64x51mm	<b>3041.U2</b>	STANDARD SIZE 2 60x49mm	<b>3041.L2</b>
STANDARD SIZE 3 66x53mm	<b>3041.U3</b>	STANDARD SIZE 3 72x54mm	<b>3041.L3</b>
STANDARD SIZE 4 69x57mm	<b>3041.U4</b>	STANDARD SIZE 4 75x57mm	<b>3041.L4</b>
STANDARD SIZE 5 71x60mm	<b>3041.U5</b>	STANDARD SIZE 5 76x59mm	<b>3041.L5</b>
STANDARD SIZE 6 73x62mm	<b>3041.U6</b>	STANDARD SIZE 6 78x61mm	<b>3041.L6</b>

# INSTRUMENTATION

Prosthesis  
Impression Tray

## IMPRESSION TRAYS N°3

Full retentive edges

UPPER

LOWER

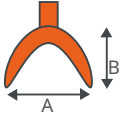
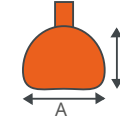

STANDARD SIZE 1 61x47mm	<b>3050.U1</b>	STANDARD SIZE 1 55x47mm	<b>3050.L1</b>
STANDARD SIZE 2 64x51mm	<b>3050.U2</b>	STANDARD SIZE 2 60x49mm	<b>3050.L2</b>
STANDARD SIZE 3 66x53mm	<b>3050.U3</b>	STANDARD SIZE 3 72x54mm	<b>3050.L3</b>
STANDARD SIZE 4 69x57mm	<b>3050.U4</b>	STANDARD SIZE 4 75x57mm	<b>3050.L4</b>
STANDARD SIZE 5 71x60mm	<b>3050.U5</b>	STANDARD SIZE 5 76x59mm	<b>3050.L5</b>
STANDARD SIZE 6 73x62mm	<b>3050.U6</b>	STANDARD SIZE 6 78x61mm	<b>3050.L6</b>

## HALF IMPRESSION TRAYS

Pierced

UPPER

LOWER

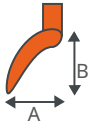

RIGHT 1 30x49mm	<b>3040.L2D</b>	LEFT 1 30x49mm	<b>3040.L2S</b>
RIGHT 2 37x57mm	<b>3040.L4D</b>	LEFT 2 37x57mm	<b>3040.L4S</b>
RIGHT 3 39x61mm	<b>3040.L6D</b>	LEFT 3 39x61mm	<b>3040.L6S</b>

# INSTRUMENTATION

Prosthesis

## KNIFE FOR IMPRESSION WITH WASH TECHNIQUE

handleDesign



453.00D

## CROWN REMOVER



105.00

## CROWN SETTER



3087.00

## TWEezer FOR ARTICULATING PAPER



MILLER PLIER

433.00

# INSTRUMENTATION

Prosthesis

## NERVE INSTRUMENTS



751.00

## FURRER PLIER



897.00





PERIODONTICS

www.acteongroup.com

Instrumentation  
YouTube Channel

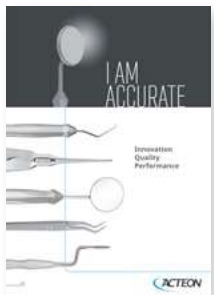

Instrumentation  
catalog

**Periodontics**.....

Scalers.....	190
Probes.....	192
Sharp Instruments.....	192
Dr Roos Periosteal Elevator .....	193











# INSTRUMENTATION

Periodontics

## DOUBLE HANDLES SCALERS

handleXL Style

	<b>GOLDMAN-FOX GFX2</b>	<b>401.02XL</b>
	<b>MAC CALL 13/14</b>	<b>403.13XL</b>
	<b>GRACEY 1/2</b>	<b>402.01XL</b>
	<b>CRANE KAPLANT MICRO CK6</b>	<b>404.09XLSPT</b>
	<b>M23</b>	<b>404.23XL</b>
	<b>GRACEY 1/2 ZRN*</b>	<b>402.01TXL</b>
	<b>CRANE KAPLAN MICRO CK6 ZRN*</b>	<b>404.05DTXL</b>
	<b>ORBAN</b>	<b>412.01XL</b>

## ENAMEL CHISELS

handleXL Style

	<b>WEDELSTAEDT (W.E.D.)</b>	<b>115.02XL</b>
---	-----------------------------	-----------------

\* Zirconium Nitride Coated

Class I medical devices - CE - Manufacturer: Prodont Holliger - France

# INSTRUMENTATION

Periodontics

## SIMPLE HANDLES SCALERS

handleDesign

	<b>TOWNER</b>	<b>410.15D</b>
	<b>I.D.I. (manufactured upon request)</b>	<b>410.16D</b>
	<b>I.N.H.</b>	<b>185.03D</b>

Other models available. To discover all the range, please consult

Catalog

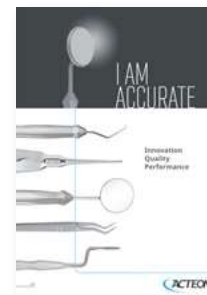

Instrumentation catalog  
REF. 8000.01

Website



[www.acteongroup.com/en/products/manual-instrumentation](http://www.acteongroup.com/en/products/manual-instrumentation)



Class I medical devices - CE - Manufacturer: Prodont Holliger - France

# INSTRUMENTATION

Periodontics

## GRADUATED CURVED PROBE

handleXL Style



Laser marker 3/6/9mm

418.02XL

## GRADUATED PROBE

handleXL Style handleDesign



WILLIAM NF14 - Foam tip  
Laser marker 3/6/9/11/13/16mm

418.00XL 418.00D



WILLIAM NF14 - Foam tip  
Laser marker 3/6/9mm

418.01XL 418.01D



FLAT TIP  
Laser marker 1/2/3/5/7/8/9/10mm

419.00XL 419.00D



Rounded tip

271.00XL 271.00D

## SIMPLE SHARP INSTRUMENTS

handleXL Style



KIRKLAND N°15

414.15XL

## DOUBLE SHARP INSTRUMENTS

handleXL Style



KIRKLAND 15/16

411.15XL

The instruments presented above correspond to the XL Style handle version

Class I medical devices - CE - Manufacturer: Prodont Holliger - France

# INSTRUMENTATION

Periodontics

## DR ROOS PERIOSTEAL ELEVATOR

3 in 1

All the advantages of an Elevator, a Retractor and the vision of an excellent Mirrors!

Indications:

- Retract soft tissues with osseous support
- The integrated mirror allows precise visual control of the surgical act during its realization

handleXL Style



407.05XL.



Setting of implant with control of the axis while drilling and screwing



Control of the elimination of the tartar and the osseous defects in the mirror



Control of the apical resection (removal of an abscess on the tip of the root) during every phase: retraction of the gum, drilling of the bone, the section of the tip of the root, curettage of the osseous basin, the preparation and the closing of the canal



- Photography under microscope or at indirect sight
- Increases depth of field

Class I medical devices - CE - Manufacturer: Prodont Holliger - France



ENDODONTICS

www.acteongroup.com

Instrumentation  
YouTube Channel



Endosurgery brochure

**Endodontics** .....

EndoSurgery Kits .....	196
EndoSurgery Instruments .....	196



# INSTRUMENTATION

Endodontics  
Kit EndoSurgery

## ENDOSURGERY KITS



**EndoSurgery Essential kit**  
11 instruments **230XL**

Mini-blade holder, flap retractor, dual probe (periodontal probe and N°17 explorer), lucas curette, inflammatory tissue curette n°1 and 2, Pure Reflect® Micro mirror Ø3 mm, Pure Reflect® Micro mirror 7x2 mm - rectangular, Micro mirror dual handle, filling material spatula, dual endo-plugger, dual plugger / burnisher instrument and mini-excavator



**EndoSurgery Integral kit**  
17 instruments **231XL**

Mini-blade holder, flap retractor, dual probe (periodontal probe and N°17 explorer), lucas curette, inflammatory tissue curette n°1 and 2, Pure Reflect® Micro mirror Ø3 mm, Pure Reflect® Micro mirror 7x2 mm - rectangular, Micro mirror dual handle, filling material spatula, dual endo-plugger, dual plugger / burnisher instrument, mini-excavator, blade holder, XL handle + Mirror Pure Reflect® N°4, Castroviejo needle holder with tungsten carbide jaws, Lagrange scissors with tungsten carbide jaws, 3-blade retractor kit and Perry tweezers

## ENDOSURGERY KIT - INSTRUMENTS



**SURGICAL CASSETTE** (without instrument)  
285x92x37 mm + 2 clips for scissors and needle-holder **233.20**



**MINI-BLADE HOLDER** **610.01XL**



**FLAP RETRACTOR** **407.16XL**



**DUAL PROBE** (periodontal probe + N°17 explorer) **263.18XL**



**LUCAS CURETTE** **135.87XL**



**INFLAMMATORY TISSUE CURETTE N°1** **412.07XL**



**INFLAMMATORY TISSUE CURETTE N°2** **412.13XL**

# INSTRUMENTATION

Endodontics  
Kit EndoSurgery

## ENDOSURGERY KIT - INSTRUMENTS



**PURE REFLECT® MICRO-MIRROR Ø3mm - round** **MP3303PH**



**PURE REFLECT® MICRO-MIRROR 7x2mm - rectangular** **MP3306RPH**



**MICRO MIRROR XL STYLE DUAL HANDLE** **210.02XL**



**FILLING MATERIAL SPATULA** **193.10XL**



**DUAL ENDO-PLUGGER** **230.00XL**



**DUAL PLUGGER / BURNISHER INSTRUMENT** **230.01XL**



**MINI-EXCAVATOR** **164.19XL**



**BLADE HOLDER** **610.00XL**



**XL STYLE HANDLE+ MIRROR PURE REFLECT® N°4** **210.36XL**



**CASTROVIEJO NEEDLE HOLDER** **747.02TC**



**LAGRANGE SCISSORS** **636.00TC**



**3-BLADE RETRACTOR KIT** **151.K**



**PERRY TWEEZERS** **222.02**



## EXTRACTION

[www.acteongroup.com](http://www.acteongroup.com)

Instrumentation  
YouTube Channel

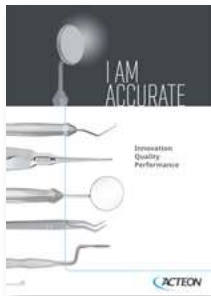

Instrumentation  
catalog

**Extraction** .....

Syndesmotomes.....	200
Elevators.....	202
Child Forceps .....	205
Adult Forceps .....	206
Curettes .....	208





# INSTRUMENTATION

Extraction

## DR BERNARD SYNDESMOTOMES



Non removable blades



Removable blades

**DR. BERNARD HANDLE** for removable blades **236.00**

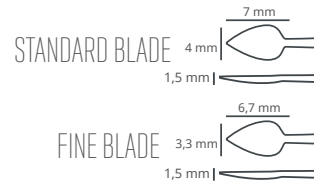

	NON REMOVABLE BLADES		REMOVABLE BLADES	
	STANDARD BLADE	FINE BLADE	STANDARD BLADE	FINE BLADE
	237.00		235.00	
	237.01	237.21	235.01	235.21
	237.02	237.22	235.02	235.22
	237.03	237.23	235.03	235.23
	237.04	237.24	235.04	235.24
	237.05	237.25	235.05	235.25
	237.06	237.26	235.06	235.26
	237.07	237.27	235.07	235.27
	237.08		235.08	235.28
	237.09		235.09	235.29
	237.11		235.11	

# INSTRUMENTATION

Extraction

## DR BERNARD SYNDESMOTOMES KITS REMOVABLE BLADES



2 HANDLES, 11 STANDARD BLADES	241.00
2 HANDLES, 9 FINE BLADES	241.01
2 HANDLES, 9 FINE BLADES, 11 STANDARD BLADES	241.02
EMPTY ALUMINIUM BOX	242.00

## CHOMPRET SYNDESMOTOMES

PLAIN HANDLE HOLLOW HANDLE

	STRAIGHT BLADE N°1	264.01	265.01
	STRAIGHT BLADE N°2	264.02	265.02
	SICKLE BLADE N°3	264.03	265.03
	FOR WISDOM TEETH N°4	264.04	265.04

## PERIOTOMES SYNDESMOTOMES

PLAIN HANDLE

	Straight, fine and flexible blade (wide 1mm)	264.10
	Straight, fine and flexible blade (wide 2mm)	264.11
	Curved, fine and flexible blade (wide 1mm)	264.12

## WARWICK-JAMES SYNDESMOTOMES

HOLLOW HANDLE

	N°1	158.01
	N°2	158.02
	N°3	158.03

# INSTRUMENTATION

Extraction

## REMOVABLE BLADES ELEVATORS



### REMOVABLE BLADES



## ELEVATORS LUXATORS



# INSTRUMENTATION

Extraction

## ELEVATORS

	STANDARD HANDLE		ERGONOMIC HANDLE	
	STANDARD HANDLE	ERGONOMIC HANDLE	STANDARD HANDLE	ERGONOMIC HANDLE
	<b>156.50</b>	<b>159.50</b>		<b>156.60</b> <b>159.60</b>
	<b>156.51</b>	<b>159.51</b>		<b>156.61</b> <b>159.61</b>
	<b>156.52</b>	<b>159.52</b>		<b>156.63</b> <b>159.63</b>
	<b>156.53</b>	<b>159.53</b>		<b>156.64</b> <b>159.64</b>
	<b>156.54</b>	<b>159.54</b>		<b>156.70</b> <b>159.70</b>
	<b>156.55</b>	<b>159.55</b>		<b>156.71</b> <b>159.71</b>
	<b>156.56</b>	<b>159.56</b>		<b>156.72</b> <b>159.72</b>
	<b>156.57</b>	<b>159.57</b>		<b>156.76</b> <b>159.76</b>
	<b>156.58</b>	<b>159.58</b>		<b>159.79</b>

## COUPLAND ELEVATORS



Other models available. To discover all the range, please consult

Catalog

Website



Instrumentation catalog  
REF. 8000.01

[www.actedgroup.com/en/products/  
manual-instrumentation](http://www.actedgroup.com/en/products/manual-instrumentation)

# INSTRUMENTATION

Extraction

## VIGNAL ELEVATORS

STANDARD HANDLE



### VIGNAL BAYONET ELEVATOR

	149.01		149.04
	149.02		149.05
	149.03		149.06

### VIGNAL ELEVATOR

	149.07		149.18
	149.10		149.19
	149.11		149.20
	149.12		149.21
	149.13		149.23
	149.14		149.24
	149.15		149.32
	149.16		149.33
	149.17		149.34

# INSTRUMENTATION

Extraction

## FORCEPS SUPER-GRIP BEAK (CHILD)

	WITH SPRING		WITHOUT SPRING	
	295.01	296.01		296.05
	295.02	296.02		296.06
	295.03	296.03		296.07
	295.04	296.04		

## STANDARD FORCEPS (CHILD)

	291.13		291.37
	291.22		291.38
	291.29		291.39
	291.33		

# INSTRUMENTATION

Extraction

## FORCEPS SUPER-GRIP BEAK (ADULT)

		UPPER		LOWER			
		SHINY	SATIN	SHINY	SATIN		
INCISORS & CANINES		290.02	1290.02	INCISORS & CANINES		290.04	1290.04
CENTRAL & CANINES		290.01	1290.01	ROOTS & INCISORS		291.74	1291.74
ROOTS		290.51	1290.51	CANINES & BICUSPIDS		290.13	1290.13
ROOTS		291.51	1291.51	CANINES & BICUSPIDS		290.75	1290.75
ROOTS, EXTRA SLIM JAWS		291.60	1291.60	BICUSPIDS		290.08	1290.08
ROOTS, SHORT EXTRA SLIM JAWS		291.61	1291.61	ROOTS		290.33	1290.33
ROOTS, EXTRA SLIM JAWS		291.62	1291.62	MOLARS		290.21	1290.21
BICUSPIDS		290.07	1290.07	MOLARS		290.22	1290.22
RIGHT MOLARS		290.17	1290.17	MOLARS		290.73	1290.73
LEFT MOLARS		290.18	1290.18	DECAYED MOLARS BROKEN CROWN		291.86	1291.86
WISDOMS		291.67	1291.67	WISDOMS		290.79	1290.79

# INSTRUMENTATION

Extraction

## SYNDESMOTOME FORCEPS

	SHINY	SATIN
SYNDESMOTOME FORCEPS LOWER ROOTS	290.23	1290.23
SYNDESMOTOME FORCEPS - UPPER	290.24	1290.24
SYNDESMOTOME FORCEPS - LOWER	290.25	1290.25

# INSTRUMENTATION

Extraction

## CHOMPRET CURETTES

handleXL Style handleDesign



N°1

134.01XL

134.01D



N°2

134.02XL

134.02D



N°3

134.03XL

134.03D



N°4

134.04XL

134.04D



N°5

134.05XL

134.05D

## GRANULATION CURETTES

handleXL Style handleDesign



N°1

131.01XL

131.01D



N°2

131.02XL

131.02D



N°3

131.03XL

131.03D

# INSTRUMENTATION

Extraction

## HEMINGWAY CURETTES

handleXL Style handleDesign



L 3.8mm

N°0

L 3.2mm

135.00XL

135.00D



L 2.8mm

N°1

L 2.8mm

135.01XL

135.01D



L 3.2mm

N°2

L 3.2mm

135.02XL

135.02D



L 3.3mm

N°3

L 3.3mm

135.03XL

135.03D

## LUCAS CURETTES

handleXL Style handleDesign



N°0

135.85XL

135.85D



N°1

135.86XL

135.86D

## LUER FRIEDMANN PLIER



FINE JAWS, 13cm

591.00

The instruments presented above correspond to the XL Style handle version

Class I medical devices - CE - Manufacturer: Prodont Holliger - France

The instruments presented above correspond to the XL Style handle version

Class I medical devices - CE - Manufacturer: Prodont Holliger - France



SURGERY

www.acteongroup.com

Instrumentation  
YouTube Channel

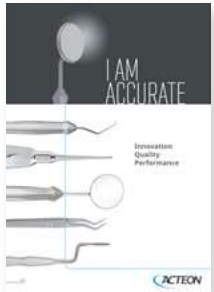

Instrumentation  
catalog

**Surgery**.....

Scissors .....	212
Tweezers.....	215
Haemostatic Forceps .....	217
Needle-Holders.....	218
Scalpels.....	219













# INSTRUMENTATION

Surgery

## GUM SCISSORS

	<b>CURVED - 11cm TC*</b>	<b>620.01TC.</b>
	<b>CURVED - 11cm</b>	<b>620.01</b>
	<b>STRAIGHT - 13cm</b>	<b>629.00</b>
	<b>CURVED - 13cm</b>	<b>630.00</b>



## GOLDMAN FOX SCISSORS

	<b>CURVED, FINE AND SHARP - 10.5cm</b>	<b>622.00</b>
	<b>CURVED, FINE AND SHARP 10.5cm TC*</b>	<b>622.00TC</b>
	<b>STRAIGHT, FINE AND SHARP - 10.5cm</b>	<b>621.00</b>
	<b>STRAIGHT, FINE AND SHARP 10.5cm TC*</b>	<b>621.00TC</b>
	<b>STRAIGHT, MICRO - 9cm</b>	<b>623.00</b>
	<b>STRAIGHT, MICRO - 9cm TC*</b>	<b>623.00TC</b>
	<b>STRAIGHT, SHARP - 11cm</b>	<b>625.00</b>
	<b>CURVED, SHARP - 11cm</b>	<b>624.00</b>
	<b>STRAIGHT, SHARP - 12cm</b>	<b>627.00</b>
	<b>STRAIGHT, SHARP - 12cm TC*</b>	<b>627.00TC</b>



# INSTRUMENTATION

Surgery







## METZENBAUM SCISSORS

	<b>STRAIGHT - 14cm</b>	<b>651.00</b>
	<b>STRAIGHT - 14cm TC*</b>	<b>651.00TC</b>
	<b>CURVED - 14cm</b>	<b>652.00</b>
	<b>CURVED - 14cm TC*</b>	<b>652.00TC</b>

## MAYO SCISSORS

	<b>STRAIGHT - 14cm</b>	<b>653.00</b>
	<b>CURVED - 14cm</b>	<b>653.01</b>

## SCISSORS

	<b>JOSEPH SCISSORS - 14cm</b>	<b>628.00</b>
	<b>DEAN SCISSORS - 17cm</b>	<b>632.00</b>
	<b>SPENCER SCISSORS - 14cm</b>	<b>633.00</b>
	<b>STRAIGHT, SHARP - 13cm</b>	<b>654.00</b>
	<b>STRAIGHT, SHARP - 13cm TC*</b>	<b>654.01TC</b>
	<b>CURVED, SHARP - 13cm</b>	<b>655.00</b>
	<b>CURVED, SHARP - 13cm TC*</b>	<b>655.01TC</b>
	<b>STRAIGHT, 1 SHARP JAWS, 1 FOAM JAWS - 13cm</b>	<b>656.00</b>

# INSTRUMENTATION

Surgery

## LAGRANGE SCISSORS



11.5cm TC\*

636.00TC



11.5cm

636.00

## CASTROVIEJO SCISSORS



STRAIGHT - 12cm TC\*

647.01TC



CURVED - 12cm TC\*

647.02TC

## NOYES SCISSORS



CURVED - 12cm

635.00

STRAIGHT - 12cm

635.01

# INSTRUMENTATION

Surgery

## TISSUE TWEEZERS



STRAIGHT - 13cm

222.04



CURVED - 13cm

222.05



STRAIGHT - 14cm

222.07



CURVED - 18cm

222.08



STRAIGHT, SERRATED JAWS - 14cm

222.06



STRAIGHT, SERRATED JAWS - 18cm

222.09



FLAT JAWS - tissue or membrane graft

222.13.

## ADSON TISSUE TWEEZERS



12.5cm

222.10



12cm

222.11



12.5cm

222.12

# INSTRUMENTATION

Surgery

## SUTURE TWEEZERS



WITH EYELETS - 15cm

428.00



WITH OPEN EYELETS - 15cm

429.00



CORN - 15cm

432.00

## GOLDMAN FOX MARKER TWEEZERS



RIGHT POCKET MARKER - 15cm

417.01



LEFT POCKET MARKER - 15cm

417.02

## BACKHAUS FIELD FORCEPS



11cm

708.00

9cm

707.00

## LUER FRIEDMANN PLIER



FINE JAWS - 13cm

591.00

# INSTRUMENTATION

Surgery

## HAEMOSTATIC FORCEPS



MOSQUITO, CURVED - 12cm

724.01



HEALSTEAD-MOSQUITO, STRAIGHT  
12cm

723.00



HEALSTEAD-MOSQUITO, CURVED  
12cm

724.00



HEALSTEAD-MOSQUITO, CURVED  
12cm

726.00



CRILLE, STRAIGHT - 14cm

729.00



CRILLE, CURVED - 14cm

730.00



PEAN, STRAIGHT - 13cm

713.00



KOCHER, CURVED - 14cm

732.00

# INSTRUMENTATION

Surgery

## NEEDLE-HOLDERS



**MATHIEU - 14cm TC\*** **743.00TC**

**MATHIEU - 14cm** **743.00**



**MATHIEU - 17cm TC\*** **744.00TC**

**MATHIEU - 17cm** **744.00**



**CASTROVIEJO, STRAIGHT - 15cm TC\*** **747.01TC**



**CASTROVIEJO, CURVED - 15cm TC\*** **747.02TC**



**CASTROVIEJO, STRAIGHT - 16cm TC\*** **747.11TC**

**CASTROVIEJO, STRAIGHT - 16cm** **747.11**



**CASTROVIEJO, CURVED - 16cm TC\*** **747.12TC**

**CASTROVIEJO, CURVED - 16cm** **747.12**

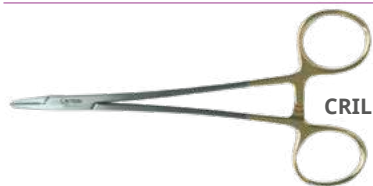

**CRILLE WOOD - 16cm TC\*** **748.00TC**

# INSTRUMENTATION

Surgery

## SCALPELS



**N°3 BARD PARKER SCALPEL HANDLE**  
for disposable sterile blade with plastic shield safety lock **600.03**



**N°4 BARD PARKER SCALPEL HANDLE**  
for disposable sterile blade with plastic shield safety lock **600.04**



**STERILE BLADE N°10 x1**  
For N°3 handle **615.10**



**STERILE BLADE N°11 x1**  
For N°3 handle **615.11A**



**STERILE BLADE N°15 x1**  
For N°3 handle **615.15G**

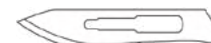

**STERILE BLADE N°23 x1**  
For N°4 handle **615.23**



**handleXL Style BLADE HOLDER**  
for easy grip and roll **610.00XL**



**ECONOMIC STANDARD HANDLE** **601.03**



**STERILE BLADE N°11 x100** **615.11**



**STERILE BLADE N°15 x100** **615.15**



IMPLANTOLOGY

[www.acteongroup.com](http://www.acteongroup.com)

Instrumentation  
YouTube Channel

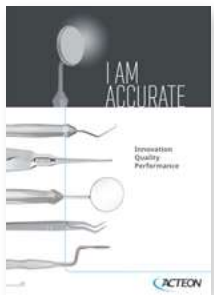

Instrumentation catalog



**Implantology**.....

Bone Chisels.....	222
Bone Files & Splitters .....	223
Osteotomes.....	224
Mallets .....	228
Retractors.....	228
Bone Spoon.....	229
Tissue Tweezers.....	229
Scissors.....	230
Castroviejo Needle-Holders .....	230
Elevators.....	231
Sinus Lift Instruments .....	232
Implantology Tray .....	232
ImplantRemover Kit.....	233



# INSTRUMENTATION

Implantology

## BONE CHISELS



**CURVED BONE CHISEL - 4mm** **415.30**



**CURVED BONE CHISEL - 3.5mm** **415.31.**



**STRAIGHT BONE CHISEL, simple bevel - 4mm** **415.10.**



**STRAIGHT BONE CHISEL, simple bevel - 6mm** **415.11**



**STRAIGHT BONE CHISEL, simple bevel - 8mm** **415.12.**



**STRAIGHT BONE CHISEL, double bevel - 4mm** **415.20**



**STRAIGHT BONE CHISEL, double bevel - 6mm** **415.21**



**STRAIGHT BONE CHISEL, double bevel - 8mm** **415.22**

## STOPS FOR BONE CHISEL & BONE SPLITTER



**BONE CHISEL STOP - 4mm** **200.01**



**BONE CHISEL STOP - 6mm** **200.02**



**BONE CHISEL STOP - 8mm** **200.03**



**ASSEMBLY TOOL** **200.20**

# INSTRUMENTATION

Implantology

## MILLER-COLBURN BONE FILES

handleXL Style



**N°2** **4522.02XL**



**N°3** **4522.03XL**

## BONE SPLITTERS



**BONE SPLITTER, square corner - 3.5mm** **150.20**



**BONE SPLITTER, square corner - 5mm** **150.21**



**BONE SPLITTER, square corner - 7mm** **150.22**



**BONE SPLITTER, conic corner - 3mm with handle** **150.31**



**BONE SPLITTER, conic corner - 4mm with handle** **150.32**



# INSTRUMENTATION

Implantology

## OSTEOTOMES



**STRAIGHT CONVEX - Ø2.7mm** **353.01.**



**STRAIGHT CONVEX - Ø3.2mm** **353.02.**



**STRAIGHT CONVEX - Ø3.7mm** **353.03**



**STRAIGHT CONVEX - Ø4.2mm** **353.04**



**STRAIGHT CONVEX - Ø5mm** **353.05**



**SET OF 5 STRAIGHT CONVEX OSTEOTOMES**  
Included: tray  
Non included: stops and assembly tools **353.11**



**STRAIGHT CONCAVE - Ø2.7mm** **354.01.**



**STRAIGHT CONCAVE - Ø3.2mm** **354.02.**



**STRAIGHT CONCAVE - Ø3.7mm** **354.03.**



**STRAIGHT CONCAVE - Ø4.2mm** **354.04.**



**STRAIGHT CONCAVE - Ø5mm** **354.05**



**SET OF 5 STRAIGHT CONCAVE OSTEOTOMES**  
Included: tray  
Non included: stops and assembly tools **354.11**

# INSTRUMENTATION

Implantology



**STRAIGHT CONIC CONVEX - Ø1.7-2.3mm** **355.01.**



**STRAIGHT CONIC CONVEX - Ø2.3-2.7mm** **355.02.**



**STRAIGHT CONIC CONVEX - Ø2.7-3.2mm** **355.03**



**STRAIGHT CONIC CONVEX - Ø3.2-3.7mm** **355.04**



**STRAIGHT CONIC CONVEX - Ø3.7-4.2mm** **355.05**



**STRAIGHT CONIC CONVEX - Ø4.2-5mm** **355.06**



**SET OF 6 STRAIGHT CONIC CONVEX OSTEOTOMES**  
Included: tray  
Non included: stops and assembly tools **355.11**



**ANGULATED CONVEX - 2.7mm** **350.01.**



**ANGULATED CONVEX - 3.2mm** **350.02.**



**ANGULATED CONVEX - 3.7mm** **350.03.**



**ANGULATED CONVEX - 4.2mm** **350.04.**

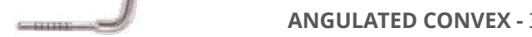

**ANGULATED CONVEX - 5mm** **350.05.**



**ANGULATED CONVEX - 5mm** **350.05.**



**ANGULATED CONVEX - 5mm** **350.05.**



**SET OF 5 ANGULATED CONVEX OSTEOTOMES**  
Included: tray  
Non included: stops and assembly tools **350.11**

# INSTRUMENTATION

Implantology

## OSTEOTOMES



**ANGULATED CONCAVE - 2.7mm**

**351.01.**



**ANGULATED CONCAVE - 3.2mm**

**351.02.**



**ANGULATED CONCAVE - 3.7mm**

**351.03.**



**ANGULATED CONCAVE - 4.2mm**

**351.04.**



**ANGULATED CONCAVE - 5mm**

**351.05.**



**SET OF 5 ANGULATED CONCAVE OSTEOTOMES**

Included: tray

Non included: stops and assembly tools

**351.11**

## STOPS FOR OSTEOTOMES



**STOP - 2.3mm**

**200.00**



**STOP - 2.7mm**

**200.11**



**STOP - 3.2mm**

**200.12**



**STOP - 3.7mm**

**200.13**



**STOP - 4.2mm**

**200.14**



**STOP - 5mm**

**200.15**



**ASSEMBLY TOOL**

**200.20**

# INSTRUMENTATION

Implantology



**ANGULATED CONIC CONVEX - Ø1.7-2.3mm**

**352.01.**



**ANGULATED CONIC CONVEX - Ø2.3-2.7mm**

**352.02.**



**ANGULATED CONIC CONVEX - Ø2.7-3.2mm**

**352.03.**



**ANGULATED CONIC CONVEX - Ø3.2-3.7mm**

**352.04.**



**ANGULATED CONIC CONVEX - Ø3.7-4.2mm**

**352.05.**



**ANGULATED CONIC CONVEX - Ø4.2-5mm**

**352.06**



**SET OF 6 ANGULATED CONIC CONVEX OSTEOTOMES**

Included: tray

Non included: stops and assembly tools

**352.11**

Other models available. To discover all the range, please consult

Catalog

Website



Instrumentation catalog  
REF. 8000.01

[www.acteongroup.com/en/products/  
manual-instrumentation](http://www.acteongroup.com/en/products/manual-instrumentation)

# INSTRUMENTATION

Implantology

## MALLETS



**TEFLON MALLET** - 19cm - 330g **213.01**



**POLITZER TEFLON MALLET** - 18cm - 150g **213.02**

## RETRACTORS



**FARABOEUF** - 12cm - x2 **151.00**



**CONTRA-ANGULED** **151.03**



**DAUTREY** - 13cm **151.02**



**DAUTREY** - 14.3cm **151.01**

# INSTRUMENTATION

Implantology

## BONE SPOON

handleXL Style handleDesign



**BONE SPOON** **407.10XL** **407.10D**



**DR FALCON BONE SPOON** **395.01XL**

## CURETTE & BONE MIXER



**BONE CURETTE** **395.00**



**BONE MIXER** **390.00**

## TISSUE TWEEZERS



**ADSON** - 12.5cm **222.10**



**ADSON** - 12cm **222.11**



**ADSON** - 12.5cm **222.12**



**FLAT JAWS** - tissue or membrane graft **222.13.**

# INSTRUMENTATION

Implantology

## LAGRANGE SCISSORS



11.5cm TC\*

636.00TC



11.5cm

636.00

## CASTROVIEJO NEEDLE-HOLDERS



STRAIGHT - 15cm TC\*

747.01TC



CURVED - 15cm TC\*

747.02TC



CURVED - 16cm TC\*

747.12TC

## METZENBAUM SCISSORS



STRAIGHT - 14cm TC\*

651.00TC



CURVED - 14cm TC\*

652.00TC

# INSTRUMENTATION

Implantology

## DR ROOS PERIOSTEAL ELEVATORS

L 4mm



handleXL Style

407.05XL.

## BUD MINI-ELEVATORS



2.5-5mm

handleXL Style

407.06XL



2-3mm

407.12XL

## MOLT ELEVATORS



4.5-3.5mm

handleXL Style

handleDesign

407.07XL

407.07D



5.5-4mm

407.08XL

407.08D



7-5mm

407.09XL

407.09D

## ELEVATORS



BENQUE - 4-6.5mm

handleXL Style

handleDesign

407.01XL

407.01D



GOLDMAN-FOX - 4.3-5.15mm

407.02XL

407.02D



PRITCHARD - 4.4-12mm

407.03XL

407.03D



HOURIGAN - 4-4.3mm

407.04XL

407.04D

The instruments presented above correspond to the XL Style handle version







Class I medical devices - CE - Manufacturer: Prodont Holliger - France

# INSTRUMENTATION

Implantology

## SINUS LIFT

handleXL Style handleDesign

	<b>DR FALCON MINI SINUS LIFT</b>	<b>150.06XL</b>	
	<b>SINUS LIFT N°0</b>	<b>150.00XL</b>	<b>150.00D</b>
	<b>SINUS LIFT N°1</b>	<b>150.01XL.</b>	<b>150.01D</b>
	<b>SINUS LIFT N°2</b>	<b>150.02XL.</b>	<b>150.02D</b>
	<b>SINUS LIFT N°3</b>	<b>150.03XL</b>	<b>150.03D</b>
	<b>SINUS LIFT N°4</b>	<b>150.04XL.</b>	<b>150.04D</b>
	<b>SINUS LIFT N°5</b>	<b>150.05XL.</b>	<b>150.05D</b>
	<b>SET OF 6 SINUS LIFT (N°1 to N°5)</b>	<b>150.11XL</b>	<b>150.11D</b>

## IMPLANTOLOGY TRAY

handleXL Style 360XL

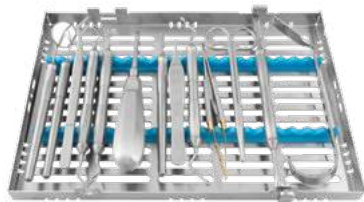

### 13 INSTRUMENTS + FREE TRAY

Contains: Mirror handle, College satin tweezer, Adson tweezer, n°6 Probe, CK6 scaler, Hemingway bone curette, Scalpel handle, H.E.I. N°1 spatula, Bone spoon, Castroviejo Needle-holder straight jaws, Joseph scissors, contraangulated retractors, Luxator elevator

The instruments presented above correspond to the XL Style handle version

Class I medical devices - CE - Manufacturer: Prodont Holliger - France

# INSTRUMENTATION

Implantology

## IMPLANT REMOVER KIT

- Less traumatizing in implant surgery, they minimize the osseous losses by avoiding bone drilling and surgery during the extraction of an implant.
- Both left and right extractors are screwed and unscrewed alternatively into the implant to gradually separate it from the bone.



### IMPLANT REMOVER KIT - LONG EXTRACTORS

Delivered with 1 sterilization tray, 1 key, 1 adapter, 1 screw extractor, 1 rounded bur and 2 long implant extractors

**300.24**

### IMPLANT REMOVER KIT - SHORT EXTRACTORS

Delivered with 1 sterilization tray, 1 key, 1 adapter, 1 screw extractor, 1 rounded bur and 2 short implant extractors

**300.25**

## SCREW EXTRACTION



Broken screw removal may be caused by:  
Excessive tightening force  
Wear

## IMPLANT EXTRACTION



Complications that may require an implant removal:  
No osteointegration / loss of osteointegration  
Positional anomalie of the implant  
Periimplantitis generating a bone loss

Class I medical devices - CE - Manufacturer: Prodont Holliger - France



ORTHODONTICS



[www.acteongroup.com](http://www.acteongroup.com)

Instrumentation  
YouTube Channel

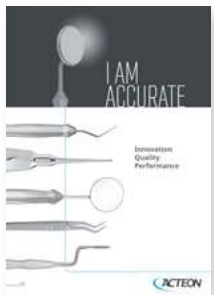

Instrumentation  
catalog

**Orthodontics** .....

Alginate Mixer.....	236
Pliers .....	237



# INSTRUMENTATION

Orthodontics

## ALGINATE MIXER

FOR ALL ALGINATES,  
IN 5 SEC., WITHOUT BUBBLE!



3055.00

Delivered with 4 bowls, 1 dosing bottle, 1 spatula, 1 mixer



1 BOWL

3055.01



1 SPATULA + 1 MIXER

3055.02



1 DOSING BOTTLE

3055.03

# INSTRUMENTATION

Orthodontics

## PLIERS



**MALLOTHY** - 12.5cm  
Wire and clasp bending pliers

877.00



**TWEED** - 14cm  
Loop bending pliers

880.00



**HOW** - 13.5cm

867.00



**ANGLE** - 12cm

876.00

Other models available. To discover all the range, please consult

Catalog

Website

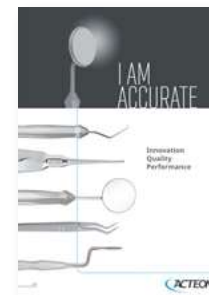

Instrumentation catalog  
REF. 8000.01



[www.actedgroup.com/en/products/  
manual-instrumentation](http://www.actedgroup.com/en/products/manual-instrumentation)



ACCESSORIES

www.acteongroup.com

Instrumentation  
YouTube Channel

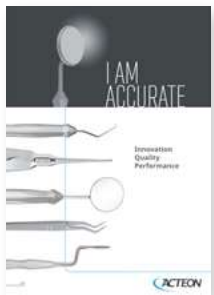

Instrumentation  
catalog

**Accessories** .....

Trays.....	240
Ultrasonic Cleaners.....	241
Burners.....	241



# INSTRUMENTATION

Accessories

## STAINLESS STEEL TRAY



**TRAY - 20x10cm**  
 Customize your trays with laser etching  
 starting from 20 pcs.

**233.10**



**TRAY - 20x15cm**  
 Customize your trays with laser etching  
 starting from 20 pcs.

**233.15**

## STERILIZATION TRAYS



**EASY CLIP TRAY**  
 180x136x30mm  
 8 instruments - Material: PSU 90g

**233.30**



**STAINLESS STEEL BIG TRAY**  
 180x280x30mm

**233.25**

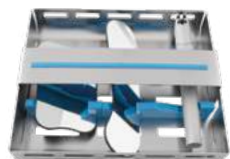

**STERILIZATION TRAY FOR PHOTOGRAPHIC MIRRORS**  
 for 3 photographic mirrors  
 or 2 photographic mirrors + 1 handle  
 (sold empty)

**233.19**



**STAINLESS STEEL TRAY WITH SILICONE**  
 4 locations - 180x130x25mm

**233.13**

**SILICONE RESTOKING GREEN - 4 instruments**

**233.16**



**STAINLESS STEEL TRAY WITH SILICONE**  
 10 locations - 180x130x25mm

**233.14**

**SILICONE RESTOKING YELLOW - 10 instruments**

**233.17**

# INSTRUMENTATION

Accessories

## ULTRASONICS CLEANERS

- Silent PEHD cover
- 2 years guarantee
- Included: 2 baskets + 1 outflow pipe



**ULTRASONICS CLEANER 3L**  
 280x180x210mm - Usable volume 2L

**PH300N**

**ULTRASONICS CLEANER 3L - 20-60°C**  
 280x180x210mm - Usable volume 2L

**PH300CN**

**ULTRASONICS CLEANER 5L**  
 280x180x260mm - Usable volume 3.2L

**PH500N**

**ULTRASONICS CLEANER 5L - 20-60°C**  
 280x180x260mm - Usable volume 3.2L

**PH500CN**

## BURNERS



**AIRHOLY® WARM AIR BURNER**

**FU37/2000R**



**PROTORCH 4 BURNER**

**FU31/0404**



**MINIFLAM GAS CARTRIDGE - 400ml - x12**

**FU47/1602**



ACTEON  
PHARMA

IT'S TIME  
TO SIMPLIFY  
LAURA'S  
TREATMENT



# PROSTHESIS & AESTHETICS

[www.acteongroup.com](http://www.acteongroup.com)

Pharma  
YouTube Channel



Expasyl Exact catalog



**Prosthesis & Aesthetics.....**

Expasyl™ Exact.....	246
Expasyl™.....	247
Algina Spray.....	248
Chromalg'x™.....	248
Orthofast™.....	249
Pralg'x.....	249
Kite Surf™.....	250
Gumak™.....	255
Cav-Hycal™.....	256
Coolsin™ Plus.....	256
PR Scell™ Glass Ionomer.....	257
PR Bond™.....	257
PR Etch™.....	258
Quick'n Post™.....	258



# PHARMA

Prosthesis & Aesthetics  
Sulcular opening

## EXPASYL™ EXACT

PRESERVED SULCULAR  
OPENING, HYGIENIC, COST  
EFFECTIVE, ONE DOSE CAPSULE



ONE CAPSULE  
= ONE PATIENT  
UP TO 3 TEETH

COST  
EFFECTIVE  
NO WASTED MATERIAL

NO ANESTHESIA  
REQUIRED,  
NO RESSION,  
NO PAIN

ASTRINGENT  
EFFECT  
NO BLEEDING

NO RISK OF  
LESION TO THE  
EPITHELIAL  
ATTACHMENT

### INDICATIONS

Expasyl™ Exact / Expasyl™ is used in all the indications of sulcular opening, such as:

- dental impression with or without prior gingival removal.
- sealing of prosthesis.
- in conservative dentistry when restoring class II and V cavities.
- placement of rubber-dam.
- orthodontia (orthodontic bands bonding

Target population: This product is intended for patients (adults and children) not subject to contra-indications and/or precautions for use. Can be used in pregnant and/or breastfeeding women.

### PROPERTIES

#### Double action

- Expasyl™ Exact / Expasyl™ generates a pressure that is 1.7 to 9.2 times greater than other retraction compounds available on the market\*.

- The compound opens the sulcus and dries it. The conventional or digital imprint is an impression of high precision.

#### More efficient

- Expasyl™ Exact / Expasyl™, during placement, generates 37 times less pressure than a cord system\*\*.
- The epithelial attachment is preserved, the risk of gingival recession and bone resorption is reduced.
- Your patient doesn't suffer.

### COMPOSITION

Aluminium chloride (≈ 15 %) ; Kaolin ; Excipients.

# PHARMA

Prosthesis & Aesthetics  
Sulcular opening

## EXPASYL™ EXACT



EXPASYL™ EXACT x 50

261 011

EXPASYL™ EXACT x 20

261 010



UNIVERSAL APPLICATOR

261 036

## EXPASYL™



EXPASYL™ MINIKIT

6 capsules + 12 straight cannulas + 1 applicator

294 100



CAPSULE STRAWBERRY FLAVOUR x 20

261 001

CAPSULE x 20

261 030



BENT CANNULAS x 40

261 045

BENT CANNULAS x 100

261 015



STRAIGHT CANNULAS x 40

261 040

STRAIGHT CANNULAS x 100

261 005



MANUAL APPLICATOR

260 900

\*Abstract #1364. American Association for Dental Research. 2012 March. \*\*Bennani V, Aarts JM, He LH. A comparison of pressure generated by cordless gingival displacement techniques. J Prosthet Dent. 2012 June;107(6):388-92.



ALGINA SPRAY

Preserving impressions



**INDICATION**

Preserving alginate and/or hydrocolloid impressions

**PROPERTIES**

- Delays drying and avoids size distortion of impressions (plaster moulding /may be delayed up to 3 days).
- Improves the quality of the plaster (quick moulding)
- Allows to produce 1 plaster model + 1 copy

**ALGINA SPRAY**

1 x 200ml pressurized bottle; 100 plasti bags

278 652

CHROMALG'X™

Alginate-based impression material



**INDICATION**

Dental impressions

**PROPERTIES**

- Chromatic alginate: its color changes according to the progression of setting reaction
- Blue color, raspberry flavour
- Setting time: 2min 20s to 2min 40s
- Complies with Standard ISO 1563: Alginate-based dental impression

**COMPOSITION**

Alginate salts, Mineral charge, Colouring agents and food flavourings

*Class I medical devices - CE  
Manufacturer: Produits Dentaires Pierre Rolland - France*

**CHROMALG'X™**

2 x 500g bags, powder and water dosing system

263 617

**CHROMALG'X™ ECO**

12 x 500g bags, powder and water dosing system

263 618

**CHROMALG'X™ CLINIC**

24 x 500g bags, powder and water dosing system

263 619

ORTHOFAST™

Alginate-based impression material



*Class I medical devices - CE  
Manufacturer: Produits Dentaires Pierre Rolland - France*

**INDICATION**

Dental impressions

**PROPERTIES**

- Very short setting time, specially for orthodontics: 1 min 40s to 2min
- Orange colour, Apricot flavour
- Complies with Standard ISO 1563:1990: Alginate-based dental impression

**COMPOSITION**

Alginate salts, Mineral charge, Colouring agents and food flavourings

**ORTHOFAST™**

2 x 500g bags, powder and water dosing system

263 621

**ORTHOFAST™ ECO**

12 x 500g bags, powder and water dosing system

263 622

**ORTHOFAST™ CLINIC**

24 x 500g bags, powder and water dosing system

263 623

PRALG'X™

Alginate-based impression material



*Class I medical devices - CE  
Manufacturer: Produits Dentaires Pierre Rolland - France*

**INDICATION**

Dental impressions

**PROPERTIES**

- High resistant alginate
- Setting time: 2min 10s to 2min 30s
- Green colour, Mint flavour
- Complies with Standard ISO 1563:1990: Alginate-based dental impression

**COMPOSITION**

Alginate salts, Mineral charge, Colouring agents and food flavourings

**PRALG'X™**

2 x 500g bags, powder and water dosing system

263 614

**PRALG'X™ ECO**

12 x 500g bags, powder and water dosing system

263 615

**PRALG'X™ CLINIC**

24 x 500g bags, powder and water dosing system

263 616

**KITE SURF™ Putty Soft**

Addition silicone for precision impressions



*Class I medical devices - CE  
Manufacturer: Produits Dentaires Pierre Rolland - France*

**INDICATION**

Dual mixture impression (1 step), wash technique impression (2 steps) or triple viscosity impression

**PROPERTIES**

- Hydrocompatible
- High viscosity
- Time management (snap-set effect)
- Bright, contrasting colors
- Bubble gum flavour

**COMPOSITION**

Polyvinylsiloxane, silica, excipients

**KITE SURF™ PUTTY SOFT Normal Setting**  
1 x 300ml jar of base, 1 x 300ml jar of catalyst, 2 spoons **281 100**

**KITE SURF™ PUTTY SOFT Fast Setting**  
1 x 300ml jar of base, 1 x 300ml jar of catalyst, 2 spoons **281 300**

**KITE SURF™ Putty Soft XL**

Addition silicone for precision impressions



*Class I medical devices - CE  
Manufacturer: Produits Dentaires Pierre Rolland - France*

**INDICATION**

Dual mixture impression (1 step), wash technique impression (2 steps) or triple viscosity impression

**PROPERTIES**

- Hydrocompatible
- High viscosity
- Time management (snap-set effect)
- Bright, contrasting colors
- Bubble gum flavour
- Cartridges compatible with all automatic mixing machines

**COMPOSITION**

Polyvinylsiloxane, silica, excipients

**KITE SURF™ PUTTY SOFT XL Normal Setting**  
2 x 380ml XL cartridges (base and catalyst); 20 mixing tips and 2 locking rings **270 012**

**KITE SURF™ PUTTY SOFT XL Ultra Fast Setting**  
2 x 380ml XL cartridges (base and catalyst); 20 mixing tips and 2 locking rings **270 004**

**KITE SURF™ XL MIXING TIPS x 50** **270 030**

**KITE SURF™ XL LOCKING RING x 2** **270 011**

**KITE SURF™ Heavy XL**

Addition silicone for precision impressions



*Class I medical devices - CE  
Manufacturer: Produits Dentaires Pierre Rolland - France*

**INDICATION**

For filling impression trays when using the double-mixing technique

**PROPERTIES**

- Heavy bodied consistency, fast setting
- Cartridges compatible with all automatic mixing machines

**COMPOSITION**

Polyvinylsiloxane, silica, catalyst, excipients

**KITE SURF™ PUTTY SOFT XL Fast Setting**  
2 x 380ml XL cartridges (base and catalyst); 20 mixing tips and 2 locking rings **270 005**

**KITE SURF™ XL MIXING TIPS x 50** **270 030**

**KITE SURF™ XL LOCKING RING x 2** **270 011**

**KITE SURF™ Monophase XL**

Addition silicone for precision impressions



*Class I medical devices - CE  
Manufacturer: Produits Dentaires Pierre Rolland - France*

**INDICATION**

Single-phase precision impression with a single material for individual impression trays

**PROPERTIES**

- Medium bodied consistency, normal setting
- Cartridges compatible with all automatic mixing machines

**COMPOSITION**

Polyvinylsiloxane, silica, catalyst, excipients

**KITE SURF™ PUTTY SOFT XL Normal Setting**  
2 x 380ml XL cartridges (base and catalyst); 20 mixing tips and 2 locking rings **270 006**

**KITE SURF™ XL MIXING TIPS x 50** **270 030**

**KITE SURF™ XL LOCKING RING x 2** **270 011**

# PHARMA

Prosthesis & Aesthetics  
Impression material

## KITE SURF™ Regular

Addition silicone for precision impressions



*Class I medical devices - CE  
Manufacturer: Produits Dentaires Pierre Rolland - France*

### INDICATION

- Corrective impression in the dual mixture technique (suitable for injection)
- Single-phase impression with individual impression carrier

### PROPERTIES

- Medium viscosity
- Total setting time: 5min 30s

### COMPOSITION

Polyvinylsiloxane, silica, catalyst, excipients

**KITE SURF™ REGULAR Normal Setting**  
2 x 50ml cartridges (base and catalyst) and 48 mixing tips **281 380**

**KITE SURF™ MIXING TIPS x 48** **281 355**

**KITE SURF™ ORAL TIPS x 96** **281 365**

**KITE SURF™ APPLICATOR** **281 155**

## KITE SURF™ Basic Light

Addition silicone for high precision impressions



*Class I medical devices - CE  
Manufacturer: Produits Dentaires Pierre Rolland - France*

### INDICATION

Dual mixture impression (1 step), wash technique impression (2 steps)

### PROPERTIES

- High hydrophily
- Low viscosity - or very fluid consistency
- Time management (snap-set effect)
- Bright, contrasting colors
- Bubble gum flavour

### COMPOSITION

Polyvinylsiloxane, silica, catalyst, excipients

**KITE SURF™ BASIC LIGHT Normal Setting**  
2 x 50ml cartridges (base and catalyst) and 48 mixing tips **281 375**

**KITE SURF™ BASIC LIGHT Fast Setting**  
2 x 50ml cartridges (base and catalyst) and 48 mixing tips **281 370**

**KITE SURF™ MIXING TIPS x 48** **281 355**

**KITE SURF™ ORAL TIPS x 96** **281 365**

**KITE SURF™ APPLICATOR** **281 155**

# PHARMA

Prosthesis & Aesthetics  
Impression material

## KITE SURF™ Light

Addition silicone for high precision impressions



*Class I medical devices - CE  
Manufacturer: Produits Dentaires Pierre Rolland - France*

### INDICATION

Dual mixture impression (1 step), wash technique impression (2 steps)

### PROPERTIES

- High hydrophily
- Low viscosity - or very fluid consistency
- Time management (snap-set effect)
- Bright, contrasting colors
- Bubble gum flavour

### COMPOSITION

Polyvinylsiloxane, silica, catalyst, excipients

**KITE SURF™ LIGHT Normal Setting**  
2 x 50ml cartridges (base and catalyst) and 48 mixing tips **281 150**

**KITE SURF™ LIGHT Fast Setting**  
2 x 50ml cartridges (base and catalyst) and 48 mixing tips **281 350**

**KITE SURF™ MIXING TIPS x 48** **281 355**

**KITE SURF™ ORAL TIPS x 96** **281 365**

**KITE SURF™ APPLICATOR** **281 155**

## KITE SURF™ Occlusion

Bite registration material



*Class I medical devices - CE  
Manufacturer: Produits Dentaires Pierre Rolland - France*

### INDICATION

Bite registration material based (addition curing silicone)

### PROPERTIES

- Colour: yellow
- Fast setting
- High viscosity
- Easy to use (good thixotropy - easily removed)
- High final hardness (easily modelled with a drill)
- High dimensional stability

### COMPOSITION

Polyvinylsiloxane, silicone dioxide, excipients

**KITE SURF™ OCCLUSION**  
2 x 50ml cartridges (base and catalyst), 12 mixing tips and 12 intraoral tips **281 175**

**KITE SURF™ OCCLUSION MIXING TIPS x 48** **281 385**

**KITE SURF™ APPLICATOR** **281 155**

**KITE SURF™ Adhésif**

Adhesive for silicone-based impression material



Class I medical device - CE  
Manufacturer: Produits Dentaires Pierre Rolland - France

**PROPERTIES**

Kite Surf™ Adhésif guarantees perfect adhesion between addition or condensation silicone-based impression materials and for slightly or non-retentive impression trays (plastic or resin)

**KITE SURF™ ADHÉSIF**  
10ml bottle with brush-stopper

**281 172**

**KITE SURF™ Rebasage**

Preparation of soft relining on removable, partial or complete prostheses with a polymethylmethacrylate base



Class I medical devices - CE  
Manufacturer: Produits Dentaires Pierre Rolland - France

**INDICATION**

Indicated for all types of removable prostheses. Kite Surf™ Rebasage: short term (< 30 days) relining on removable prostheses. Establishes the prosthesis permitting masticatory load absorption of the alveolar and mucosal ridges. Favours tissue healing after surgery and extractions.

**PROPERTIES**

- Water-repellent
- Convenient and fast, they allow considerable time saving
- Excellent adhesion to the base of the prosthesis

**COMPOSITION**

Kite Surf™ Rebasage are addition silicones (polyvinyl siloxane) two-component, autopolymerizing, packaged in cartridge

**KITE SURF™ REBASAGE**

1 x 50ml Cartridge of Kite Surf™ Rebasage, 6 Mixing tips, 1 x 4ml Kite Surf™ Rebasage Primer, 1 x 5ml Kite Surf™ Rebasage Varnish A, 1 x 5ml Kite Surf™ Rebasage Varnish B, 1 Finishing cutter, 12 Small brushes, 1 Disposable cutter handle, 1 Mixing plate

**281 420**

**GUMAK™ Addition Putty Soft**

Impression material based on addition curing silicone (vinyl polysiloxane)



Class I medical devices - CE  
Manufacturer: Produits Dentaires Pierre Rolland - France

**INDICATION**

Double mixing technique (1 phase); Dual impression technique (wash-technique; 2 phases)

**PROPERTIES**

Complies with ISO 4823 standard "Dentistry - Elastomeric impression materials"

**COMPOSITION**

Polyvinylsiloxane, Silica, Excipients

**GUMAK™ ADDITION PUTTY SOFT Normal Setting**  
1 x 300ml jar of base, 1 x 300ml jar of catalyst, 2 spoons

**241 120**

**GUMAK™ ADDITION PUTTY SOFT Fast Setting**  
1 x 300ml jar of base, 1 x 300ml jar of catalyst, 2 spoons

**241 100**

**GUMAK™ Addition Light**

Hydro-compatible impression material based on addition curing silicone (vinyl polysiloxane)



Class I medical devices - CE  
Manufacturer: Produits Dentaires Pierre Rolland - France

**INDICATION**

Corrective impression in the dual impression (wash-technique) and in the dual mixture techniques

**PROPERTIES**

Complies with ISO 4823 standard "Dentistry - Elastomeric impression materials"

**COMPOSITION**

Polyvinylsiloxane, Silica, Excipients

**GUMAK™ ADDITION LIGHT Normal Setting**  
2 x 50ml cartridges (base and catalyst) and 12 single-use mixing tips

**264 300**

**GUMAK™ ADDITION LIGHT Fast Setting**  
2 x 50ml cartridges (base and catalyst) and 12 single-use mixing tips

**264 200**

**KITE SURF™ MIXING TIPS x 48**

**281 355**

**KITE SURF™ ORAL TIPS x 96**

**281 365**

**KITE SURF™ APPLICATOR**

**281 155**

## CAV-HYCAL™

Light-curing, radiopaque one-component  
material containing calcium hydroxide

## INDICATIONS

- Indirect pulp capping
- As a cavity liner under all restorative materials

## PROPERTIES

- One-component material
- Radiopaque.
- High compressive strength

Class IIa medical device (MEDCERT) - CE 0482

Manufacturer: MP Medical Product - Germany

Distributed by: Produits Dentaires Pierre Rolland SAS - France Only available in the European Union

## CAV-HYCAL™

2 x 2ml syringes and 20 disposable tips

213 876

## COOLSIN™ PLUS

Self-cure resin for  
temporary bridges and crowns

## INDICATION

Preparation of temporary crowns and bridges

## PROPERTIES

- Natural and aesthetic shades
- Flexural strength > 100 MPa
- Self-cure material & fast setting time
- Easy finishing & polishing

Class IIa medical device (TUV Rheinland) - CE 0197

Manufacturer: G-Pharma - France

Distributed by: Produits Dentaires Pierre Rolland SAS - France

## COOLSIN™ PLUS

1 double cartridge of 50ml, 10 single-use mixing tips

201 070

## COOLSIN™ PLUS FELD x 100

200 073

For more information, please consult our website



www.acteongroup.com/en/products/equipment

PR SCELL™  
GLASS-IONOMER

Cementation of crowns, bridges and inlays



## PROPERTIES

- Excellent handling properties
- Low film thickness
- Long working time
- It releases fluoride
- Radiopaque

Complies with ISO 9917-1 "Dentistry - Water-based cements - Part 1: Powder/liquid acid-base cements"

## COMPOSITION

- Powder: fluoroaluminosilicate glass, excipients
- Liquid: acrylic acid and tricarboxylic acid copolymers, excipients

Class IIa medical device (GMed) - CE 0459

Manufacturer: Produits Dentaires Pierre Rolland - France

## PR SCELL™ GLASS-IONOMER

15g of powder, 8ml of liquid, 1 powder spoon

213 770

## PR BOND™

Light &amp; dual-cure desensitizing bonding system



## PROPERTIES

- Light & dual cure: Used alone, Part A is a light-cure bonding. When mixed with Part B (activator), the bonding system become dual-curing
- Shear strength : ~ 13 Mpa
- No post-operative sensitivity, due to the action of benzalkonium chloride
- Fluoride release

Class IIa medical device (TUV Rheinland) - CE 0197

Manufacturer: G-Pharma - France

Distributed by: Produits Dentaires Pierre Rolland SAS - France

## PR BOND™

2 bottles of liquid (5ml adhesive + 5ml catalyst)

200 948



PR ETCH™

Etching gel for the surface treatment  
of enamel and dentin



Class IIa medical device (TUV Rheinland) - CE 0197  
Manufacturer: G-Pharma - France  
Distributed by: Produits Dentaires Pierre Rolland SAS - France

**PROPERTIES**

- Thixotropic gel: remains in place on the tooth but easy and fast wash off, without residues
- Blue color for a good contrast

**COMPOSITION**

- 38% phosphoric acid

PR ETCH™  
4 x 1.5g syringe of gel, 8 felt applicators

200 322

QUICK'n POST™

Glass fiber endodontic posts and drills



**INDICATION**

Posts for dental reconstruction, particularly for teeth with little or no remaining crown tissue

- Size 0: inferior incisors (refill only)
- Size 1: inferior incisors and first superior premolars
- Size 2 and 3: superior incisors, canines, premolars, molars

**PROPERTIES**

- Translucent glass fiber
- Conical-cylindrical shape respecting the shape of the root canal
- Highly resistant: modulus of elasticity similar to dentin
- Retentive surface: highly adhesion with cements
- Radiopaque
- Biocompatible
- Single use [posts]
- Easy to identify thanks to its coloured central axis
- Easy to remove, if clinically required, its coloured soft micro-fiber filament permits to guide instruments for drilling it

**COMPOSITION**

- Post: composite reinforced with glass fiber (≈ 70% in vol) in an epoxy resin matrix
- Drill: stainless steel

Class IIa medical device (Kiwa) - CE 0476  
Manufacturer: OVERFIBERS S.r.l. - Italy  
Distributed by: Produits Dentaires Pierre Rolland SAS - France

QUICK'n POST™



QUICK'N POST SIZE (mm)	0	1	2	3
MAXIMUM DIAMETER	1.20	1.40	1.60	1.80
MINIMUM DIAMETER	0.70	0.80	0.80	0.90
CONICITY (%)	0.04	0.05	0.066	0.08
LENGHT	19	19	19	19



**QUICK'N POST™**

Kit: 15 posts (5 size 1, 5 size 2, 5 size 3) + 3 drills

251 185



**POSTS** size 0 x 10

251 189



**POSTS** size 1 x 10

251 186

**POSTS** size 2 x 10

251 187

**POSTS** size 3 x 10

251 188

**DRILL** size 0 x 1

251 181

**DRILL** size 1 x 1

251 182

**DRILL** size 2 x 1

251 183

**DRILL** size 3 x 1

251 184





ENDODONTICS

[www.acteongroup.com](http://www.acteongroup.com)

Pharma  
YouTube Channel



**Endodontics**.....

Edetat.....	262
Salvizol™ E.D.T.A.....	262
MTA* Caps.....	263
Hycal™.....	263
Cortisomol™ SP Kit.....	264
Eugenol Pur.....	264
Sealite™ Regular Kit.....	265
Cimavit™.....	266
Cimavit™ Photo.....	266
Resosolv.....	267
Desocclusol™ Orange.....	267



\* Mineral Trioxide Aggregate

EDETAT

Root canal conditioner (chelator)



Class IIa medical device (GMed) - CE 0459  
Manufacturer: Produits Dentaires Pierre Rolland - France

**PROPERTIES**

EDETAT enables the removal of pathological mineral material (various denticles, calcifications) and the enlargement of narrow or difficult-to-access canals. It solubilizes organic debris and lubricates the instruments used for canal wound care.

**COMPOSITION**

Edetic acid: 14% under dihemipotassium salt form, excipients

EDETAT™  
14ml bottle

231 201

SALVIZOL™ E.D.T.A

Root canal irrigant



Class IIa medical device (GMed) - CE 0459  
Manufacturer: Produits Dentaires Pierre Rolland - France

**PROPERTIES**

Thanks to its chelating properties, Salvizol™ E.D.T.A. dissolves the mineralizing screen, facilitating removal of the smear layer. It contains a quaternary ammonium salt to efficiently wet the dentin wall and produce a foam, thus avoiding apical sedimentation of debris.

When used in combination with sodium hypochlorite (NaClO), Salvizol™ E.D.T.A. makes it possible to obtain clean dentin walls and satisfactory opening of the tubules, so that the canal can then be optimally obturated.

**COMPOSITION**

Edetic acid: 8g/100g under dihemipotassium salt form, excipients

SALVIZOL™ E.D.T.A.  
250ml bottle

266 115

For more information, please consult our website



[www.acteongroup.com/en/products/equipment](http://www.acteongroup.com/en/products/equipment)

MTA\* CAPS

Endodontic repair cement



MTA Caps: Class IIa medical device (MEDCERT) - CE 0482  
Appli caps: Class I medical device - CE  
Manufacturer: First Scientific Dental GmbH - Germany  
Distributed by: Produits Dentaires Pierre Rolland SAS - France

**INDICATIONS**

- Root end filling (retrograde)
- Repair of root perforations during root canal therapy
- Pulp capping
- Root end filling (orthograde)

**PROPERTIES**

- Biocompatible
- Barrier impervious to bacteria and fluids
- Radiopaque
- Easy to use
- Delivered under single-use capsules

\* Mineral Trioxide Aggregate

**MTA\* CAPS**

1 aluminium bag with 2 pre-proportioned 0.3g-capsules

251 170

**MTA\* APPLI CAPS**

213 675

HYCAL™

Ready-to-use calcium hydroxide paste



Class IIa medical device (MEDCERT) - CE 0482  
Manufacturer: MP Medical Product GmbH - Germany  
Distributed by: Produits Dentaires Pierre Rolland SAS - France

**INDICATIONS**

- Hycal™ is a calcium hydroxide paste indicated for application:
- Direct capping when pulp opened or after pulpotomy.
  - Indirect capping for treatment of deep caries.
  - Temporary filling of root-canals.

**PROPERTIES**

- Product ready to use.
- High pH (>12.5)
- Effective protection of the pulp.
- Formation of tertiary dentin.
- Radio-opaque.

Only available in the European Union

**HYCAL™**

1 x 2ml syringe with a bended application cannula (+ tube cap)  
and 2 additional bended application cannulas

259 314

# PHARMA

Endodontics  
Filling

## CORTISOMOL™ SP KIT

Powder for permanent sealing cement  
for root canals



Cortisolol™ SP Powder: Class III medical device (GMED) - CE 0459  
Spoon: Class I medical device - CE  
Manufacturer: Produits Dentaires Pierre Rolland - France

**PROPERTIES**

Prednisolone acetate is a steroidal anti-inflammatory agent with good local and systemic safety. It is used for the relief of post-operative pain following root canals work. In addition, Cortisolol™ SP powder is radiopaque and, although without any colouring agent, its colour makes the canal entry easily visible. The cement produced must be used in combination with gutta-percha cones.

**COMPOSITION**

Prednisolone acetate 1.1%; Diiodothymol; Zinc oxide; Baryum sulphate; Excipients

**CORTISOMOL™ SP KIT**

Jar containing 25g of powder; 1 spoon

**221 606**

## EUGENOL PUR

Liquid for zinc-oxide based cement



Class IIa medical device (GMed) - CE 0459  
Manufacturer: Produits Dentaires Pierre Rolland - France

**PROPERTIES**

The eugenol confronted with bivalent metallic ions (Zn<sup>2+</sup>) forms a chelate: chemopolymerization. To be used with Cortisolol™ SP powder.

**COMPOSITION**

Eugenol 100%

**EUGENOL PUR**

60ml bottle

**234 110**

# PHARMA

Endodontics  
Filling

## SEALITE™ REGULAR KIT

Powder and liquid for permanent  
sealing cement for root canals



Sealite™ Regular Powder and Sealite™ Liquid: Class IIa medical devices (GMED) - CE 0459  
Spoon and dropper: Class I medical device - CE  
Manufacturer: Produits Dentaires Pierre Rolland - France

**PROPERTIES**

- Cement that spreads completely into canals
- Very thin film thickness
- Very low disintegration
- Must be used in combination with gutta-percha cones
- Easy to handle: adequate working time, setting time that allows placement of gutta cones whatever the procedure used

**COMPOSITION**

- Sealite™ Regular powder: Diiodothymol - Zinc oxide - Radio-opacifier - Excipients
- Sealite™ Liquide: Eugenol - Excipients

**SEALITE™ REGULAR KIT**

25g of Sealite™ Regular Powder, 10ml of Sealite™ Liquide, 1 spoon, 1 dropper

**266 264**

**SEALITE™ LIQUIDE**

10ml (refill)

**266 267**

For more information, please consult our website



[www.acteongroup.com/en/products/equipment](http://www.acteongroup.com/en/products/equipment)

CIMAVIT™

Zinc oxide-based temporary filling cement



PROPERTIES

- Ready-to-use (no mixing)
- Waterproof
- Very good adherence to dentine
- Immediate setting time in mouth
- Easy to remove (probe, excavator, ...)
- Pink colour for a good contrast

*Class IIa medical device (TUV Rheinland) - CE 0197  
Manufacturer: G-Pharma - France  
Distributed by: Produits Dentaires Pierre Rolland SAS - France*

CIMAVIT™  
6 x 28g jars

213 859

CIMAVIT™ PHOTO

Light-curing filling material for  
temporary restorations



INDICATIONS

All types of temporary fillings, temporary protection in inlay and onlay techniques

PROPERTIES

Ready-to-use material, does not stick to instruments, condensable, does not require a particular finishing of the cavity, ensures an hermetic seal (isolates the tooth from bacterial and thermal aggression).

In case of more than two weeks' stay in mouth, and in occlusal or marginal areas, reinforcement with composite is recommended. Good aesthetic translucency. Its elastic consistency facilitates its removal in one bloc.

*Class IIa medical device (Medcert) - CE 0482  
Manufacturer: MP Medical Product GmbH - Germany  
Distributed by: Produits Dentaires Pierre Rolland SAS - France*

*Only available in the European Union*

CIMAVIT™ PHOTO  
2 x 4g syringes

213 830

RESOSOLV™

Solvent for phenol-formol type  
root canal filling cements



INDICATION

Solvent for phenol-formol type root canal filling cements (phenoplast resins)

PROPERTIES

- Ready to use
- Facilitates the passage of retreatment instruments

COMPOSITION

Dimethylformamide, excipients

*Class IIa medical device (GMed) - CE 0459  
Manufacturer: Produits Dentaires Pierre Rolland - France*

RESOSOLV™  
14ml bottle

266 112

DESOCCLUSOL™  
ORANGE

Solvent for eugenate  
root canal filling cements



PROPERTIES

Facilitates mechanically the removing of the fillings from the root-canal:

- High dissolving capacity of zinc-oxide / eugenol based cement and gutta percha
- Improves the effectiveness of instruments
- Good local tolerability

COMPOSITION

Orange essential oil

*Class IIa medical device (GMed) - CE 0459  
Manufacturer: Produits Dentaires Pierre Rolland - France*

DESOCCLUSOL™ ORANGE  
14ml bottle

226 022

▶ ANESTHETICS & OTHERS

[www.acteongroup.com](http://www.acteongroup.com)

Pharma  
YouTube Channel



**Anesthetics & Others .....**

Etik™ Collagene .....	270
Hemostasyl™ .....	270
Soie Dentaire .....	271
Sitsalicine™ .....	272
Biosplint .....	273
Primacaïne™ Adrenaline 1/200 000 .....	274
Primacaïne™ Adrenaline 1/100 000 .....	274
Xylorolland sans Vasoconstricteur .....	275
Xylorolland avec Adrenaline .....	275
Frijet™ .....	276
Aiguilles Dentaires Stériles .....	277

ETIK™ COLLAGENE

Haemostatic surgical dressing



PROPERTIES

Collagen is a fibrillar protein naturally present in all connective tissues. Lyophilized collagen in cylindrical form displays hemostatic activity due to its adhesive power, liquid absorption and gelification properties. The collagen cylinder moulds itself into the hemorrhagic surface where it adheres strongly upon mechanical compression, thus promoting the formation and maintenance of a platelet clot (coagulation). The collagen cylinders are resorbable.

COMPOSITION

Native, non-denatured, lyophilized bovine collagen (mainly type I collagen): 100%. This device contains tissues of animal origin under regulation (EU) no. 722/2012. Dimensions: diameter ≈ 10mm, height ≈ 16mm

*Class III medical device (GMed) - CE 0459  
Manufacturer: Produits Dentaires Pierre Rolland - France*

ETIK™ COLLAGENE

25 unit-packaged sterile cylinders (in blister packs)

281 970

HEMOSTASYL™

Haemostatic dressing with mechanical action



INDICATION

To be used in all cases of moderate bleeding occurring in routine dental practice (scaling, etc.)

PROPERTIES

- Thixotropic properties
- Good adhesion to the gingival mucosa, without compression
- Presence of aluminum chloride which reinforces its mechanical haemostatic effect
- Placed directly in the mouth with the single-use angled cannula
- Easily located due to its color
- Easily removed by gentle water spray without resumption of bleeding
- Painless on a healthy periodontium
- Contact time: 2 minutes max.

*HemostasyL™ Syringes: Class IIIa medical device (GMED) - CE 0459  
HemostasyL™ Cannulas: Class I medical device - CE  
Manufacturer: Produits Dentaires Pierre Rolland - France*

HEMOSTASYL™ KIT

2 x 2g-syringes + 40 cannulas

246 200

HEMOSTASYL™ SERINGUES

2 x 2g-syringes

246 050

HEMOSTASYL™ CANNULAS

40 cannulas

246 100

SOIE DENTAIRE

Non-resorbable silk strands



INDICATION

Dental suture in dental surgery and stomatology

PROPERTIES

- Soie dentaire 3/0: Needle: length 18mm, radius of curvature 3/8ème, non-traumatising triangular shape. Strand: diameter Dec 2, length 45cm.
- Soie dentaire 4/0: Needle: length 12mm, radius of curvature 3/8ème, non-traumatising triangular shape. Strand: diameter Dec 1,5, length 45cm.
- Soie Dentaire is non-resorbable silk strands obtained by braiding varying numbers of silk strands depending on the desired thickness. Soie Dentaire is coated with natural wax after braiding. It is black, not very elastic but very flexible. It is easy to handle and improves surgical comfort considerably as it has almost no shape memory.

COMPOSITION

- Needle: stainless steel
- Strand: silk = proteinic fibre (fibroin) made essentially of repeated amino-acids sequences from the unwinding of silkworm's cocoons

*Class IIb medical device (GMED) - CE 0459  
Manufacturer: PETERS SURGICAL - France  
Distributed by: Produits Dentaires Pierre Rolland SAS - France*

DENTAL SILK SUTURES 4/0 DEC 1

36-pouch case

280 200

DENTAL SILK SUTURES 3/0 DEC 1

36-pouch case

280 100

For more information, please consult our website



[www.acteongroup.com/en/products/equipment](http://www.acteongroup.com/en/products/equipment)



# PHARMA

Anesthetics & Others  
Polishing

## SITSALICINE™

Polishing teeth after scaling



*Class IIa medical device (GMED) - CE 0459  
Manufacturer: Produits Dentaires Pierre Rolland - France*

**SITSALICINE™**  
60g tube

**PROPERTIES**

Silica is a mildly abrasive powder which gives the paste its polishing properties, eliminating the micro-roughness that is present after scaling, without damaging the enamel or gums. A flavouring compound gives its pleasant, refreshing taste.

**277 803**

# PHARMA

Anesthetics & Others  
Splinting

## BIOSPLINT™

Splinting ribbons



*Class IIa medical device (GMED) - CE 0459  
Manufacturer: Produits Dentaires Pierre Rolland - France*

**BIOSPLINT™ RIBBONS**  
8 ribbons

**INDICATIONS**

- Stabilization of mobile teeth
- Temporary replacement of missing teeth
- Reinforcement or repairing of temporary or permanent bridges
- Maintain of inter-dental spaces

**PROPERTIES**

- Low thickness avoids any oral embarrassment
- May remain in place for many years
- Treatment with supercritical fluids: improves impregnation of the fibre by composite.

**201 661**

For more information, please consult our website



[www.acteongroup.com/en/products/equipment](http://www.acteongroup.com/en/products/equipment)

**PRIMACAÏNE™**  
ADRÉNALINE 1/200 000

**Injectable solution for dental use**



**INDICATION**

Local or loco-regional anaesthesia in odonto-stomatological practice

**ITS ADVANTAGES**

- Contains 4% Articaine Hydrochloride and 1/200,000 adrenaline
- Less manufacturing stages: Faster manufacturing procedure making it possible to reduce the potential risks of oxidation of the adrenaline
- Sodium edetate-free
- Low Sulphite content\*: 0.85mg sodium metabisulphite per cartridge, i.e. 0.337mg/ml in equivalent SO<sub>2</sub>

\* Preservative for vasoconstrictors with antioxidant properties

*This product is a medicinal product. Available only if registered by the National Competent Authorities. Not available in EEC except France*

**PRIMACAÏNE™ ADRENALINE 1/200 000**  
Box of 50 cartridges

**262 220**

**PRIMACAÏNE™**  
ADRÉNALINE 1/100 000

**Injectable solution for dental use**



**INDICATION**

Local or loco-regional anaesthesia in odonto-stomatological practice. This presentation is especially suitable for procedures requiring a high degree of ischaemia

**ITS ADVANTAGES**

- Contains 4% Articaine Hydrochloride and 1/100,000 adrenaline
- Less manufacturing stages: Faster manufacturing procedure making it possible to reduce the potential risks of oxidation of the adrenaline
- Sodium edetate-free
- Low Sulphite content\*: 0.85mg sodium metabisulphite per cartridge, i.e. 0.337mg/ml in equivalent SO<sub>2</sub>

\* Preservative for vasoconstrictors with antioxidant properties

*This product is a medicinal product. Available only if registered by the National Competent Authorities. Not available in EEC except France*

**PRIMACAÏNE™ ADRENALINE 1/100 000**  
Box of 50 cartridges

**262 215**

**XYLOROLLAND™**  
SANS VASOCONSTRICTEUR

**Injectable solution for dental use**



**INDICATION**

- Local or loco-regional anaesthesia in odonto-stomatological practice
- This preparation is particularly used when the use of a vasoconstrictor is not recommended

**ITS ADVANTAGES**

- Contains 2% Lidocaine Hydrochloride
- Low sodium metabisulphite content: 0.15%

*This product is a medicinal product. Available only if registered by the National Competent Authorities. Not available in EEC except France*

**XYLOROLLAND™ SANS VASOCONSTRICTEUR**  
Box of 50 cartridges

**291 462**

**XYLOROLLAND™**  
AVEC ADRÉNALINE

**Injectable solution for dental use**



**INDICATION**

Local or loco-regional anaesthesia in odonto-stomatological practice

**ITS ADVANTAGES**

- Contains 2% Lidocaine Hydrochloride and 1/80,000 adrenaline
- Total absence of sodium edetate
- Low sodium metabisulphite content: 0.055%
- Optimisation of the formula by adjustment of the pH to 3.8
- pH more compatible with the stability of the active principles, particularly adrenaline

*This product is a medicinal product. Available only if registered by the National Competent Authorities. Not available in EEC except France*

**XYLOROLLAND™ AVEC ADRENALINE**  
Box of 50 cartridges

**291 422**

FRILJET™



*Class IIa medical device (GMED) - CE 0459  
Manufacturer: Produits Dentaires Pierre Rolland - France*



This product induces a tissue temperature reduction down to - 25°C, and may cause tissue necrosis if the directions for use are not respected. Routinely use FRILJET™ with the cannula.

**FRILJET™ SPRAY**  
200g (171.5ml) bottle + cannula

**239 803**

**Local cryoanaesthesia  
Pulp vitality test (cold sensivity)**

**INDICATION**

- Local cryoanaesthesia for short procedures: abscess incision, extraction of deciduous teeth, roots, pyorrhic teeth, desensitisation of the injection point
- Pulp vitality test: Lowering of the temperature of the dental enamel causes a stimulation of the dental pulp (slight pain) making it possible to check the vitality of the tooth tested.

**PROPERTIES**

The tetrafluoroethane contained in Friljet™ exerts an anaesthetic action by cooling: its fast evaporation from the surface to which it is applied causes a significant reduction of the temperature of this surface for several dozen of seconds. When the temperature reduction reaches the synaptic transmission threshold, surface anaesthesia occurs.

For more information, please consult our website



[www.acteongroup.com/en/products/equipment](http://www.acteongroup.com/en/products/equipment)

AIGUILLES DENTAIRES  
STÉRILES

**Hypodermic injections in local anaesthesia**



*Sterile dental needles 8/40, 12/30 and 21/40:  
Class IIa medical devices (GMED) - CE 0459  
Manufacturer: Produits Dentaires Pierre Rolland - France  
Sterile dental needles 16/30, 21/30 and 35/50:  
Class IIa medical devices (BSI) - CE 2797  
Manufacturer: SOFIC - France  
Distributed by: Produits Dentaires Pierre Rolland SAS - France*

**PROPERTIES**

- European thread pitch
- Plastic hub
- Silicone coated
- Triple bevel allowing several injections without the risk of bending the point of the bevel and thus obstructing the lumen of the needle
- Sterile
- Complies with NF EN ISO 7885 standard "Dentistry - Sterile injection needles for single use"



**RISK OF PUNCTURE:** Reminder of the protocol in force: After a purpose anaesthesia do not put the protective cap back on the needle by hand. The cap is placed on the work surface and picked up with the needle. Possibility of using a needle destroyer. In all cases used needles must be placed in specific containers provided for this purpose with a view to their destruction.

STERILE DENTAL NEEDLES 8/40	201 451
STERILE DENTAL NEEDLES 12/30	201 450
STERILE DENTAL NEEDLES 16/30	201 444
STERILE DENTAL NEEDLES 21/30	201 445
STERILE DENTAL NEEDLES 21/40	201 456
STERILE DENTAL NEEDLES 35/50	201 448



HYGIENE

[www.acteongroup.com](http://www.acteongroup.com)

Pharma  
YouTube Channel



Riskontrol catalog



**Hygiene** .....

Riskontrol® .....	280
Riskontrol® Adapters.....	282
Septol™ Gloves .....	284
Septol™ Aspiration.....	286
Septol™ Rotative .....	286
Septol™ Empreinte.....	287
Septol™ Instruments Enzymatic.....	287
Septol™ Savon Doux.....	288
Septol™ Spray.....	289



# PHARMA

## RisKontrol®

ADOPT SAFE DISPOSABLE TIPS SOLUTION FOR OUTSTANDING CLINICAL PROTECTION



Hygiene  
Disposable tips

<b>PROTECTION</b> 20 TIMES LESS CROSS CONTAMINATION RISKS*	<b>FLEXIBLE</b> TOTAL RESPECT OF THE PATIENT'S ANATOMY	<b>UNIVERSAL</b> SUITABLE TO ALL AIR/WATER SYRINGE	<b>ECONOMICAL</b> SIMPLIFY YOUR PROCESS SAVE YOUR TIME	<b>ECOLOGICAL</b> ENVIRONMENTALLY-FRIENDLY
---	---	---	---	---

### REDUCES CROSS-CONTAMINATION RISKS

- Single-use, disposable tips
- Protection for the patient and the health care professional
- 20 times less risk of direct or cross-contamination\* thanks to single-use
- 2 separate tubes guide air and water from the syringe to the end of the tip, ensuring totally dry air



### PROPERTIES

The Riskontrol® tips are intended for single-use, with a rounded end for the patient's comfort. The new design improves the set-up of the tip on the adapter with a bayonet attachment system.

### COMPOSITION

The Riskontrol® tips are made of entirely recyclable polyethylene. This material is environmentally friendly and non-polluting in the case of combustion.

\*M.Inger, V.Bennani, M.Farella, F.Bennani, RD.Cannon. Efficacy of air/water syringe tip sterilization. Australian Dental Journal 2014; 59: 87-92

# PHARMA

Hygiene  
Disposable tips



## Classic by Riskontrol®

	<b>250 NON STERILE WHITE TIPS</b>	<b>201 664</b>
	<b>250 NON STERILE BLUE TIPS</b>	<b>201 665</b>
	<b>250 NON STERILE YELLOW TIPS</b>	<b>201 666</b>
	<b>250 NON STERILE GREEN TIPS</b>	<b>201 667</b>
	<b>250 NON STERILE PINK TIPS</b>	<b>201 668</b>

## Total Protec by Riskontrol®

	<b>100 NON STERILE WHITE TIPS with plastic sheath</b>	<b>201 751</b>
	<b>100 NON STERILE BLUE TIPS with plastic sheath</b>	<b>201 750</b>

## Art by Riskontrol®

	<b>250 NON STERILE ORANGE/MANDARINE TIPS</b>	<b>201 701</b>
	<b>250 NON STERILE GREY/LIQUORICE TIPS</b>	<b>201 702</b>
	<b>250 NON STERILE GREEN/ANIS TIPS</b>	<b>201 703</b>
	<b>250 NON STERILE PURPLE/BLACK CURRENT TIPS</b>	<b>201 704</b>
	<b>250 NON STERILE WHITE/MINT TIPS</b>	<b>201 700</b>

Class I medical devices - CE - Manufacturer: Produits Dentaires Pierre Rolland - France

## Stérile by Riskontrol®

	<b>96 TIPS UNDER INDIVIDUAL BLISTERS sterilized with ethylene oxide</b>	<b>201 770</b>
---	---	----------------

Class Is medical device (GMED) - CE 0459 - Manufacturer: Produits Dentaires Pierre Rolland - France

# PHARMA

## Hygiene Adapters





















### Ris|Kontrol®

The Riskontrol® range includes different adapters able to equip about 145 types of dental chairs.

The adapter is left permanently in place. You just need to change the tips between each patient.





















#### Adapters for air/water syringes

The adapters are delivered with 1 protective cap and, depending on the types, with a replacement O-ring to ensure optimal functioning of your syringe. Contact your area dealer to determine the correct adapter for your dental chair.

 <b>ADEC INOX (NV)</b> 200 195	 <b>BELMONT NEW (NV)</b> 200 158
 <b>CAS INOX (NV)</b> 200198	 <b>CASTELLINI LOGO NEW (NV)</b> 200 184
 <b>CASTELLINI V (NV)</b> 200 163	 <b>CEFLA INOX (NV)</b> 200 197
 <b>D.C.I. (NV)</b> 200 152	 <b>DENTALEZ (NV)</b> 200 164
 <b>ENGLE (NV)</b> 200 194	 <b>FA E (NV)</b> 200 165
 <b>FA E2 (NV)</b> 200 166	 <b>FA C (NV)</b> 200 167
 <b>FA C2 (NV)</b> 200 168	 <b>FA S1 (NV)</b> 200 182
 <b>FLEX (NV)</b> 200 169	 <b>GNATUS INOX (NV)</b> 200 149
 <b>KAVO C (NV)</b> 200 171	 <b>KAVO DB (NV)</b> 200 157
 <b>KAVO E (NV)</b> 200 172	 <b>KAVO GB (NV)</b> 200 156

# PHARMA

## Hygiene Adapters

 <b>KAVO HB (NV)</b> 200 153	 <b>KAVO IB (NV)</b> 200 192
 <b>KAVO J (NV)</b> 200 181	 <b>KAVO K (NV)</b> 200 160
 <b>LU INOX (NV)</b> 200 150	 <b>LU V (NV)</b> 200 173
 <b>LU NEW INOX (NV)</b> 200 199	 <b>MORITA 66 TYPE 2 (NV)</b> 200 159
 <b>MORITA S12 (NV)</b> 200 183	 <b>MORITA INOX WS10 (NV)</b> 200 201
 <b>MORITA INOX WS97 (NV)</b> 200 200	 <b>RITTER COMBIJET (NV)</b> 200 175
 <b>RITTER TOP JET (NV)</b> 200 176	 <b>SIEMENS 2000 (NV)</b> 200 177
 <b>SIEMENS 4000 (NV)</b> 200 178	 <b>SIEMENS E (NV)</b> 200 179
 <b>SIRONA B (NV)</b> 200 154	 <b>SIRONA L (NV)</b> 200 196
 <b>TRIDAC II (NV)</b> 200 190	 <b>YOSHIDA V (NV)</b> 200 180
 <b>YOSHIDA 3 (NV)</b> 200 193	



**SEPTOL™**  
N.P. ALOE VERA

Powder-free latex examination gloves with aloe vera



**PROPERTIES**

With aloe vera; Ambidextrous; Powder free; Semi-rough outside surface; Non sterile; single use

- Manufactured to offer a maximum of strength, without sacrificing the necessary tactility; a very severe quality control guarantees the best hygiene conditions, so imperious today, to the practitioner, his staff and patients
- Complies with ASTM\* F1671-07 "Bacteriophage penetration test", ASTM D3578-05 "Specifications for rubber examination gloves", ASTM D6124-06 "Residual powder on medical gloves", ASTM D5712-10 "Extractable proteins" and ASTM D5151-06 "Detection of holes in medical gloves"

**COMPOSITION**

Very high quality latex (natural polymer produced by a tree called "Hevea Brasiliensis"), Aloe Vera, additives

\* Internationally recognized American Standards

Class I medical devices - CE  
Manufacturer: Produits Dentaires Pierre Rolland - France

**SEPTOL™ POWDER-FREE LATEX GLOVES WITH ALOE VERA**  
10 boxes containing 100 gloves each

<b>XS size</b>	<b>219 500</b>	<b>S size</b>	<b>219 505</b>
<b>M size</b>	<b>219 510</b>	<b>L size</b>	<b>219 515</b>

For more information, please consult our website



[www.acteongroup.com/en/products/equipment](http://www.acteongroup.com/en/products/equipment)

**SEPTOL™**  
N.P.

Powder-free latex examination gloves



**PROPERTIES**

Ambidextrous; Powder free; Semi-rough outside surface; Non sterile; single use

- Manufactured to offer a maximum of strength, without sacrificing the necessary tactility
- Complies with ASTM\* F 1671-07 "Bacteriophage penetration", ASTM D 3578-05 "Specifications for rubber examination gloves", ASTM D 6124-06 "Residual powder on medical gloves", ASTM D 5712-10 "Extractable proteins" and ASTM D 5151-06 "Detection of holes in medical gloves"

**COMPOSITION**

Very high quality latex (natural polymer produced by a tree called "Hevea Brasiliensis"), additives

\* Internationally recognized American Standards

Class I medical devices - CE  
Manufacturer: Produits Dentaires Pierre Rolland - France

**SEPTOL™ POWDER-FREE GLOVES**  
10 boxes containing 100 gloves each

<b>XS size</b>	<b>219 400</b>	<b>S size</b>	<b>219 405</b>
<b>M size</b>	<b>219 410</b>	<b>L size</b>	<b>219 415</b>

**SEPTOL™**  
N.P. NITRILE

Powder-free nitrile examination gloves



**PROPERTIES**

Colour: blue; Neutral pH approaching the one of the skin; Ambidextrous; Powder free; Pebble outside surface; Non sterile; single use

- Manufactured to offer a maximum of strength, without sacrificing the necessary tactility; a very severe quality control guarantees the best hygiene conditions, so imperious today, to the practitioner, his staff and patients.
- Complies with ASTM\* D 6319-10 "Specifications for nitrile examination gloves" and ASTM D 5151-06 "Detection of holes in medical gloves"

**COMPOSITION**

Butadiene-acrylonitrile copolymer; Synthetic elastomer; Vulcanization agent: carbamate derivative

Class I medical devices - CE  
Manufacturer: Produits Dentaires Pierre Rolland - France

**SEPTOL™ GLOVES NITRILE**  
1 box containing 100 gloves each

<b>XS size</b>	<b>219 278</b>	<b>M size</b>	<b>219 279</b>
<b>L size</b>	<b>219 280</b>		

# PHARMA

Hygiene  
Cleaning / Disinfection

## SEPTOL™ ASPIRATION



*Class IIa medical device (GMED) - CE 0459  
Manufacturer: DMD - France  
Distributed: Produits Dentaires Pierre Rolland SAS - France*

**Cleaning and disinfection of suction system  
in a dental environment**

**PROPERTIES**

- Bactericide in 15min, 1%, 20°C (EN 13727, EN 14561)
- Yeasticide in 15min, 1%, 20°C (EN 13624, EN 14562)
- Tuberculocide in 60min, 1.6%, 20°C (EN 14348, EN 14563)
- Active in accordance with EN 14476 in 5min, 20°C, against BVDV (surrogate of HCV) at 0.50%, Herpesvirus and HIV-1 at 1% and Vaccinia virus at 2%

*Hazardous - Respect precautions for use. Read the label and the information about the product before use.*

**SEPTOL™ ASPIRATION**  
5 litre-bottle with a 20cc dosing pump

**268 297**

## SEPTOL™ ROTATIVE



*Class IIb medical device (GMED) - CE 0459  
Manufacturer: Laboratoires Anios - France  
Distributed: Produits Dentaires Pierre Rolland SAS - France*

**Cleaning and disinfection of burs, rotary and canal  
instruments before sterilization**

Ready to use solution

**PROPERTIES**

- Bactericide in 5min, 20°C (EN 1040, EN 13727, EN 14561)
- Yeasticide in 5min, 20°C (EN 1275, EN 13624, EN 14562)
- Tuberculocide in 60min, 20°C (EN 14348, EN 14563)
- Active in accordance with EN 14476 in 5min, 20°C, against PRV (Surrogate of HBV), Herpesvirus, BVDV (Surrogate of HCV), Vaccinia virus, HIV-1

*Hazardous - Respect precautions for use. Read the label and the information about the product before use.*

**SEPTOL™ ROTATIVE**  
2 litre-bottle

**268 305**

**SEPTOL™ ROTATIVE IMMERSION TANK**

**268 326**

# PHARMA

Hygiene  
Cleaning / Disinfection

## SEPTOL™ EMPREINTE



*Class IIa medical devices (GMED) - CE 0459  
Manufacturer: Produits Dentaires Pierre Rolland - France*

**Concentrate disinfectant liquid for impressions**

**PROPERTIES**

- Septol™ Empreinte is an aldehyde-free concentrated disinfectant with a wide range of action prepared and tested in compliance with new harmonised European disinfection regulations.
- Septol™ Empreinte has been designed for high-level, rapid disinfection of impressions (addition and condensation), in silicone, alginate, polyether and polysulphur: the impressions remain unaltered, have no significant dimensional change and are compatible with plasters.

**EFFICACY (MICROORGANISMS)**

- Bactericidal (S.aureus, P.aeruginosa, E.hirae) in 10min, 1% (EN 13727)
- Yeasticidal (C.albicans) in 10min, 1% (EN 13624)
- Tuberculocidal (M.terrae) in 10min, 1% (EN 14348)
- Limited virocidal (Poliovirus, Adénovirus, Parvovirus including HIV, HBV, HCV) in 10min, 1% (EN 14476)

**SEPTOL™ EMPREINTE**  
1 litre-bottle

**268 322**

**SEPTOL™ EMPREINTE IMMERSION TANK**

**268 325**

## SEPTOL™ INSTRUMENTS ENZYMATIC

**Cleaning and disinfection of dental instrumentation  
before sterilization**



*Class IIb medical device (GMED) - CE 0459  
Manufacturer: Laboratoires Anios - France  
Distributed: Produits Dentaires Pierre Rolland SAS - France*

**PROPERTIES**

- Bactericide in 5min, 0.5%, 20°C (EN 1040, EN 13727, EN 14561)
- Active against MDRB in 5min, 0.5%, 20°C (EN 13727)
- Yeasticide in 5min, 0.5%, 20°C (EN 1275, EN 13624, EN 14562)
- Active in accordance with EN 14476 in 5min, 0.5%, 20°C, against PRV (surrogate of HBV), BVDV (surrogate of HCV), Herpesvirus, Vaccinia virus, HIV-1

*Hazardous - Respect precautions for use. Read the label and the information about the product before use.*

**SEPTOL™ INSTRUMENTS ENZYMATIC**  
Concentrated product to dilute (1%) with a 20ml dosing pump

**268 291**

**SEPTOL™ INSTRUMENTS ENZYMATIC IMMERSION TANK**

**268 375**

**SEPTOL™  
SAVON DOUX**

Liquid soap - Frequent use



*This product is covered by the regulation on cosmetics products*

**INDICATIONS**

Septol™ Savon Doux is perfectly suitable for repeated hand washing. The properties of its ingredients make it suitable for use on all types of skin.

**PROPERTIES**

- Washing solution
- Enriched with moisturizing substance
- Standard NF EN ISO 11930 criteria A: Assessment of the antimicrobial protection (challenge test) against: Pseudomonas aeruginosa, Staphylococcus aureus, Escherichia coli, Candida albicans, Aspergillus niger
- Weekly recontamination test conducted for 15 weeks against: Pseudomonas aeruginosa (CIP 82 118), Staphylococcus aureus (CIP 4 83), Candida albicans (CIP 48 72), Aspergillus niger (ATCC 16404)

**SEPTOL™ SAVON DOUX**  
1 litre-bottle with 4ml dosing pump\*

**268 507**

**SEPTOL™ SAVON DOUX**  
5 litre-bottle with tap\*

**268 506**

**SEPTOL™ SAVON DOUX**  
1 litre-bottle for wall dispenser

**268 510**

**METAL WALL DISPENSER**

**260 511**

**SEPTOL™  
SPRAY**

Fast-acting disinfectant



Ready to use solution

**INDICATIONS**

Disinfection of previously cleaned, non-immersible, non-invasive, alcohol resistant medical devices. Use in a dental environment.

**PROPERTIES**

- Bactericide in 5min, 20°C (EN 1040, EN 13727, EN 13697)
- Active against MRSA in 5min, 20°C (EN 13727)
- Yeasticide in 5min, 20°C (EN 1275, EN 13624, EN 13697)
- Fungicide in 15min, 20°C (EN 1275, EN 13624, EN 13697)
- Active in accordance with EN 14476 in 1min, 20°C, against PRV (surrogate of HBV), BVDV (surrogate of HCV), Vaccinia virus, Herpesvirus

*Class IIa medical device (GMED) - CE 0459  
Manufacturer: Laboratoires Anios - France  
Distributed: Produits Dentaires Pierre Rolland SAS - France*

*Hazardous - Respect precautions for use. Read the label and the information about the product before use.*

**SEPTOL™ SPRAY**  
750 ml with a foaming spray

**268 301**

**SEPTOL™ SPRAY**  
5L-bottle with tap

**268 300**

For more information, please consult our website



[www.acteongroup.com/en/products/equipment](http://www.acteongroup.com/en/products/equipment)



ACTEON  
OEM



# ULTRASONICS

[www.acteongroup.com](http://www.acteongroup.com)

**Ultrasonics**.....

SP NEWTRON® .....	294
SP NEWTRON® LED.....	296
SP 4055 NEWTRON® .....	298
Xinetic .....	299
Cords .....	300
Handpieces .....	302
Ultrasonic Accessories.....	303



OEM

Ultrasonics  
SP Newtron®

# SP NEUTRON



60x50x33mm  
28-36kHz  
0.1 to 12W  
Supply Voltage: 24Vac / 30VA; 34Vdc  
Settings: analog or digital



**SP NEUTRON® 4K 5V Module**  
with connectors

**F55297**



**SP NEUTRON® 4K 5V Module**  
with wires

**F55298**



**SP NEUTRON® 4K3 7V Module**  
with US special connection

**F55287**

*Class IIa medical device (GMED) - CE 0459 - Manufacturer: SATELEC® - France*

## STANDARD KITS

### with LIGHT GREY cord



		Cord					
		Ø	Length	Ref.	Handpiece	Potentiometer	Tips
<b>F55292</b>	SP Newtron 4K 5V	4x6	2070	F00195	F12281	F00524	1, 2, 10P
<b>F55349</b>	SP Newtron 4K 5V with connectors	6x8	2070	F00239	F12281	F00524	1, 2, 10P

### with DARK GREY cord



		Cord					
		Ø	Length	Ref.	Handpiece	Potentiometer	Tips
<b>F55311</b>	SP Newtron 4K 5V	7x10	1500	F00426	F12281	F00524	1, 2, 10P
<b>F55375</b>	SP Newtron 4.7K 5V	4x6	2300	F00187	F12281	-	1, 2, 10P

OEM

Ultrasonics  
SP Newtron®

## B.LED KITS

### with LIGHT GREY cord



		Cord					
		Ø	Length	Ref.	Handpiece	Potentiometer	Tips
<b>F56260</b>	SP Newtron Slim BLED handpiece	4.5x5.6	2080	F01200	F12905	F00522	1, 2, 10P

### with DARK GREY cord



		Cord					
		Ø	Length	Ref.	Handpiece	Potentiometer	Tips
<b>F56262</b>	SP Newtron Slim BLED handpiece	4.5x5.6	2080	F01201	F12905	F00522	1, 2, 10P

## SPECIFIC KITS

### with LIGHT GREY cord



		Cord					
		Ø	Length	Ref.	Handpiece	Potentiometer	Tips
<b>F55299</b>	SP Newtron	6x8	2070	F00239	F12281	F00524	1, 2, 10P

### with MEDIUM GREY cord



		Cord					
		Ø	Length	Ref.	Handpiece	Potentiometer	Tips
<b>F55383</b>	SP Newtron INTL 81" G3	5x7	1900	F01154	F12281	-	1, 2, 10P
<b>F55385</b>	SP Newtron INTL 61" G3	5x7	1400	F01153	F12281	-	1, 2, 10P
<b>F55453</b>	SP Newtron INTL 81"	5x7	1900	F01154	F12281	F00525	1, 2, 10P

### with DARK GREY cord



		Cord					
		Ø	Length	Ref.	Handpiece	Potentiometer	Tips
<b>F55372</b>	SP Newtron	4x6	2300	F00150	F12281	-	1, 2, 10P

### with SURF 6 GREY cord



		Cord					
		Ø	Length	Ref.	Handpiece	Potentiometer	Tips
<b>F55285</b>	SP Newtron INTL 61"	5x7	1400	F00184	F12281	-	1, 2, 10P
<b>F55452</b>	SP Newtron INTL 81"	5x7	1900	F00188	F12281	F00525	1, 2, 10P
<b>F56274</b>	SP Newtron 4K 5V	5x7	2300	F01180	F12281	E51745	1, 2, 10P



OEM

Ultrasonics  
SP Newtron® LED

# SP NEWTRON LED



75x49x33mm  
28-36kHz  
0.1 to 12W  
Supply Voltage: 24Vac / 30VA; 34Vdc  
Settings: analog or digital



**SP NEWTRON® LED 4K 5V Module**  
with connectors

**F55527**



**SP NEWTRON® LED 4K 5V Module**  
with wires

**F55528**



**SP NEWTRON® LED 4K3 7V Module**  
with US special connection

**F55529**

*Class IIa medical device (GMED) - CE 0459 - Manufacturer: SATELEC® - France*

OEM

Ultrasonics  
SP Newtron® LED

## STANDARD KITS

### with LIGHT GREY cord

		Cord					
		Ø	Length	Ref.	Handpiece	Potentiometer	Tips
<b>F55506</b>	SP Newtron LED 4K 5V	5x7	2070	F00606	F12609	F00524	1, 2, 10P
<b>F55543</b>	SP Newtron LED 4K 5V 6x8 cord	6x8	2070	F00614	F12609	F00524	1, 2, 10P

### with MEDIUM GREY cord

		Cord					
		Ø	Length	Ref.	Handpiece	Potentiometer	Tips
<b>F55525</b>	SP Newtron LED	5x7	2300	F00633	F12609	F00524	1S, 2, 10P

### with DARK GREY cord

		Cord					
		Ø	Length	Ref.	Handpiece	Potentiometer	Tips
<b>F55374</b>	SP Newtron LED 4,7K 5V	6x8	2300	F00618	F12609	-	1, 2, 10P
<b>F55507</b>	SP Newtron LED	6x8	2300	F00618	F12609	F00524	1, 2, 10P

## SPECIFIC KITS

### with MEDIUM GREY cord

		Cord					
		Ø	Length	Ref.	Handpiece	Potentiometer	Tips
<b>F55454</b>	SP Newtron LED INTL 81"	5x7	1900	F00633	F12609	F00525	1, 2, 10P
<b>F55501</b>	SP Newtron LED	7x10	1900	F00607	F12609	F00524	1, 2, 10P

### with SURF 6 GREY cord

		Cord					
		Ø	Length	Ref.	Handpiece	Potentiometer	Tips
<b>F55510</b>	SP Newtron LED	5x7	1400	F00616	F12609	F00526	1, 10Z, H3
<b>F55512</b>	SP Newtron LED	5x7	2300	F01182	F12609	F00524	1, 2, 10P

OEM

Ultrasonics  
SP 4055 Newtron®

SP 4055 NEWTRON

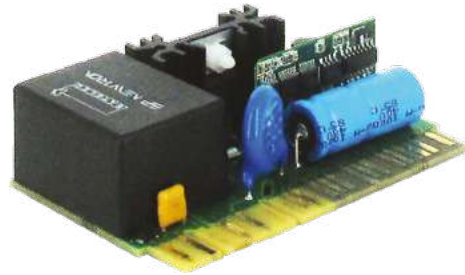

**SP 4055 Newtron Module**

**F55270**

*Class IIa medical device (GMED) - CE 0459 - Manufacturer: SATELEC® - France*

**with DARK GREY cord**



		Cord						
		Ø	Length	Ref.	Handpiece	Potentiometer	Tips	
<b>F55377</b>	SP 4055 Newtron LED	6x8	2300	F00618	F12609	-	1, H3, K15-21	
<b>F56268</b>	SP 4055 Newtron	6x8	2300	F01157	F12281	-	1, H3, K15-21	

Ultrasonics  
Xinetic

OEM

XINETIC



**XINETIC Module**

**F55089**

*Class IIa medical device (GMED) - CE 0459 - Manufacturer: SATELEC® - France*

**with LIGHT GREY cord**



		Cord						
		Ø	Length	Ref.	Handpiece	Potentiometer	Tips	
<b>F55090</b>	OEM Xinetic LG Kit	4x6	2070	F00195	F12200	F55088	1	

**with MEDIUM GREY cord**



		Cord						
		Ø	Length	Ref.	Handpiece	Potentiometer	Tips	
<b>F55091</b>	OEM Xinetic MG Kit	5x7	2070	F01154	F12200	-	1	

**with DARK GREY cord**



		Cord						
		Ø	Length	Ref.	Handpiece	Potentiometer	Tips	
<b>F55092</b>	OEM Xinetic DG Kit	4x6	2300	F00187	F12200	-	1	

OEM

Ultrasonics  
Cords

STANDARD CORDS

	<b>LIGHT GREY SILICONE CORD</b> Ø 4x6; L 2070cm	<b>F00195</b>
	<b>LIGHT GREY SILICONE CORD</b> Ø 6x8; L 2070cm	<b>F00239</b>
	<b>MEDIUM GREY NEWTRON® CORD 61"</b> Ø 5x7; L 1400cm	<b>F01153</b>
	<b>MEDIUM GREY NEWTRON® CORD 81"</b> Ø 5x7; L 1900cm	<b>F01154</b>
	<b>DARK GREY P359 SILICONE CORD</b> Ø 4x6; L 2300cm	<b>F00150</b>
	<b>DARK GREY P107 SILICONE CORD</b> Ø 4x6; L 2300cm	<b>F00187</b>
	<b>DARK GREY CORD</b> Ø 7x10; L 1500cm	<b>F00426</b>
	<b>DARK GREY CORD</b> Ø 6x8; L 2300cm	<b>F01157</b>
	<b>SURF 6 GREY NEWTRON® CORD 61"</b> Ø 5x7; L 1400cm	<b>F00184</b>
	<b>SURF 6 GREY NEWTRON® CORD 81"</b> Ø 5x7; L 1900cm	<b>F00188</b>
	<b>SURF 6 GREY SILICONE CORD</b> Ø 6x8; L 2300cm	<b>F00234</b>

OEM

Ultrasonics  
Cords

LED CORDS

	<b>LIGHT GREY OEM LED CORD</b> Ø 5x7; L 2070cm	<b>F00606</b>
	<b>LIGHT GREY NEWTRON® LED CORD</b> Ø 6x8; L 2070cm	<b>F00614</b>
	<b>LIGHT GREY NEWTRON® SLIM LED CORD</b> Ø 4.5x5.6; L 2080cm	<b>F01200</b>
	<b>MEDIUM GREY FEDESA* LED CORD</b> Ø 7x10 ; L 1900m	<b>F00607</b>
	<b>MEDIUM GREY NEWTRON® LED CORD 81"</b> Ø 5x7; L 1900cm	<b>F00633</b>
	<b>MEDIUM GREY NEWTRON® SLIM LED CORD</b> Ø 4.5x5.6; L 2080cm	<b>F01201</b>
	<b>DARK GREY NEWTRON® LED CORD</b> Ø 6x8; L 2300cm	<b>F00618</b>
	<b>DARK GREY NEWTRON® SLIM LED CORD</b> Ø 4.5x5.6; L 2080cm	<b>F01202</b>
	<b>SURF 6 GREY LED CORD</b> Ø 5x7 ; L 2300m	<b>F01182</b>
	<b>SURF 6 GREY LED CORD</b> Ø 5x7 ; L 1400m	<b>F00616</b>

OEM

Ultrasonics  
Handpieces

HANDPIECES



**SUPRASSON HANDPIECE**  
autoclavable, light grey

**F12200**



**NEWTRON® HANDPIECE**  
autoclavable, light grey/dark grey

**F12281**



**NEWTRON® TITANIUM HANDPIECE**  
autoclavable, light grey/dark grey

**F12252**



**NEWTRON® LED HANDPIECE**  
autoclavable

**F12609**



**NEWTRON® LED TITANIUM HANDPIECE**  
autoclavable

**F12689**



**NEWTRON® LED HANDPIECE - LOW VOLTAGE**  
autoclavable

**F12607**



**NEWTRON® SLIM HANDPIECE**  
with white LED ring

**F12901**



**NEWTRON® SLIM B.LED HANDPIECE**  
with white LED ring

**F12905**

OEM

Ultrasonics  
Handpieces

HANDPIECES ACCESSORIES



**LED RING**  
for NEWTRON® LED handpiece

**F12605**



**LED RING - LOW VOLTAGE**  
for low voltage NEWTRON® LED handpiece

**F12606**



**NEWTRON® SLIM B.LED BLUE LED RING**  
for low voltage NEWTRON® Slim B.LED handpiece

**F62201**



**NEWTRON® SLIM B.LED WHITE LED RING**  
for low voltage NEWTRON® Slim B.LED handpiece

**F12915**



**NEWTRON® SLIM B.LED WHITE LED RING**

**F12932**



**NEWTRON® SLIM B.LED BLUE LED RING**

**F12934**

OEM

Ultrasonics  
Accessories



**POTENTIOMETER 4.7K**

**F00522**



**COLOR SP NEWTRON® POTENTIOMETER 4.7K**

**F00524**



**XINETIC POTENTIOMETER**

**F55088**



**LUX HANDPIECE SAV OEM KIT**

to LED handpiece LUX  
Delivered with low voltage LED handpiece, low voltage LED ring, 2 resistances kit, light grey LED handpiece OEM cord Ø5x7 (2.07m) and 3 o'rings seal + o'ring tool

**F12686**



**WIRING EXTENSION SP NEWTRON®**

**F55205**

**WIRING EXTENSION SP NEWTRON® LED**

**F55522**



**SP NEWTRON® DUMMY LOAD**

**F00021**

OEM

Ultrasonics  
Accessories

**IRRIGATION**



**STERIPUMP KIT WITHOUT MODULE**

Delivered with 2 autoclavable irrigation lines and 10 perforators

**F28653**



**STERIPUMP MODULE**

**F28660**



**STERIPUMP + MODULE KIT**

Delivered with a Steri Pump, Steri Pump module, 2 autoclavable irrigation lines and 10 perforators

**F28652**

**COMPLETE STERIPUMP KIT**

Delivered with a Steri Pump, Steri Pump module, 2 autoclavable irrigation lines and 10 perforators, 5 clips, a 4.7K potentiometer

**F28650**



# MOTORS

[www.acteongroup.com](http://www.acteongroup.com)

<b>Motors</b> .....	
Motors Modules .....	308
Motors .....	308
Cords.....	309





# OEM

## Motors

### MODULES



**M6 MODULE**  
without option

*F34300*



**M6P MODULE**  
Pneumatic option with connectors

*F34304*

### MOTORS



**LIGHT MOTOR**

*F28600*



**AV40 MOTOR**  
External spray

*F28502*



**IS40 MOTOR**  
Internal spray

*F28602*

# OEM

## Motors

### CORDS



**MEDIUM GREY CORD**  
for light and IS motors

*F33711*



**MEDIUM GREY CORD**  
for AV motor

*F33712*



**BLACK COILED CORD**  
for light motor

*F33713*



# POLYMERIZATION

[www.akteongroup.com](http://www.akteongroup.com)

**Polymerization** .....

MiniLED™ OEM .....	312
MiniLED™ Supercharged OEM.....	313
MiniLED™ Module.....	314
MiniLED™ Cords .....	314
MiniLED™ Accessories .....	315



OEM

Polymerization  
Curing Light

**MINILED**  
OEM



**MINI LED™ OEM HANDPIECE**

**F02710**

**MINI LED™ OEM WITH MODULE**

Delivered with a handpiece, a module, a Ø7.5mm opalescent guide and an oval light shield and with:

- Surf 6 grey cord **F02505**
- Medium grey cord **F02719**
- Dark grey cord **F02720**
- Gray 3 (Medium grey) cord **F02538**

Delivered with a handpiece, a module, a Ø7.5mm opalescent guide and 2 caps and with:

- Light grey cord **F02715**

**MINI LED™ OEM WITHOUT MODULE**

Delivered with a handpiece, a Ø7.5mm opalescent guide and an oval light shield and with:

- Medium grey cord **F02693**
- Dark grey cord **F02694**

Delivered with a handpiece, a Ø7.5mm opalescent guide and 2 caps and with:

- Light grey cord **F02714**

\*Adec is registered trademark

Class I medical devices - CE - Manufacturer: SATELEC® - France

OEM

Polymerization  
Curing Light

**MINILED**  
SUPERCHARGED  
OEM



**MINI LED™ SUPERCHARGED OEM HANDPIECE**

**F05218**

**MINI LED™ SUPERCHARGED OEM**

Delivered with a handpiece, a module, a Ø7.5mm opalescent guide and an oval light shield and with:

- Light grey cord **F05205**
- Medium grey cord **F05206**
- Dark grey cord **F05207**
- Surf 6 grey cord **F05208**

\*Adec is registered trademark

Class I medical devices - CE - Manufacturer: SATELEC® - France

# OEM

## Polymerization Accessories

### MODULE



MINI LED™ OEM MODULE

F02730

### CORDS



DARK GREY CORD

F02721



MEDIUM GREY CORD

F02722



LIGHT GREY CORD

F02723

SURF 6 GREY CORD

F02326

GRAY 3 (MEDIUM GREY) CORD

F02327



For standard accessories, please refer to tabletop curing lights p 126-133

# OEM

## Polymerization Accessories

### ACCESSORIES



OPALESCENT LIGHT GUIDE Ø7.5mm

F02648



OPALESCENT LIGHT GUIDE Ø5.5mm

F02652



OPALESCENT AMBER LIGHT GUIDE Ø7.5mm

F02620



OPALESCENT LIGHT GUIDE Ø7.5mm SCANWAVE

F02648



OPALESCENT LIGHT GUIDE Ø5.5mm SCANWAVE

F02652



OVAL LIGHT SHIELD

F05407



AUTOCLAVABLE CAPS Ø7.5mm x5

F61507



AUTOCLAVABLE CAPS Ø5.5mm x5

F61505



AUTOCLAVABLE CAPS Ø7.5mm x5  
AUTOCLAVABLE CAPS Ø5.5mm x5

F61515



# INTRAORAL CAMERAS

[www.acteongroup.com](http://www.acteongroup.com)

**Intraoral Cameras.....**

Modules.....	318
Linking Cables Mini Dock U USB2 .....	319
Configuration of Dock U.....	321
Linking Cables Dock MU USB2 .....	322



OEM

Intraoral Cameras

**MODULE**



**MINI DOCK U USB2**

Built-in docking station with USB2 output  
Please select the accessories for this module on page 52.

**MINI DOCK  
U\_USB2**

*Class I medical devices - CE - Manufacturer: Sopro - France*

**LINKING CABLES FOR BUILT-IN DOCKING STATIONS TYPE U WITHOUT SHEATH**

Length 2.5m **922144**

Length 5m **922145**

Length 7m **922146**

**LINKING CABLES FOR BUILT-IN DOCKING STATIONS TYPE MU WITHOUT SHEATH**

Length 2.5m **922062**

Length 5m **922063**

Length 7m **922064**

OEM

Intraoral Cameras  
Linking cables Mini Dock U USB2

**LINKING CABLES SATELEC®**

**INSTRUMENT HOLDER**  
Length 2.5m **922147**

**INSTRUMENT HOLDER**  
Length 5m **922148**

**INSTRUMENT HOLDER**  
Length 7m **922149**

**CATTANI Ø21 SUCTION HOLDER**  
Length 5m **922150**

**UK PENDING CORD HOLDER**  
Length 2.5m **922151**

**UK PENDING CORD HOLDER**  
Length 5m **922152**

**UK PENDING CORD HOLDER**  
Length 7m **922153**

**LINKING CABLES ADEC\* 500**

**INSTRUMENT HOLDER**  
Length 2m **922154**

**INSTRUMENT HOLDER**  
Length 5m **922155**

**INSTRUMENT HOLDER**  
Length 7m **922156**

**CATTANI Ø21 SUCTION HOLDER**  
Length 2m **922157**

**CATTANI Ø21 SUCTION HOLDER**  
Length 5m **922158**

**CATTANI Ø21 SUCTION HOLDER**  
Length 7m **922159**

**UK PENDING CORD HOLDER**  
Length 2m **922138**

**UK PENDING CORD HOLDER**  
Length 5m **922160**

**UK PENDING CORD HOLDER**  
Length 7m **922139**

*\*Adec is registred trademark*



**LINKING CABLES ADEC\* 300**

<b>UK PENDING CORD HOLDER</b> Length 2m	<b>922140</b>
<b>UK PENDING CORD HOLDER</b> Length 7m	<b>922141</b>

**LINKING CABLES BELMONT\* 500**

<b>INSTRUMENT HOLDER</b> Length 2.5m	<b>922161</b>
<b>INSTRUMENT HOLDER</b> Length 5m	<b>922162</b>
<b>INSTRUMENT HOLDER</b> Length 7m	<b>922163</b>
<b>CATTANI Ø21 SUCTION HOLDER</b> Length 2.5m	<b>922164</b>
<b>CATTANI Ø21 SUCTION HOLDER</b> Length 5m	<b>922165</b>
<b>UK PENDING CORD HOLDER</b> Length 7m	<b>922166</b>

**LINKING CABLES FEDESA\* 500**

<b>INSTRUMENT HOLDER</b> Length 2.5m	<b>922167</b>
<b>INSTRUMENT HOLDER</b> Length 5m	<b>922168</b>
<b>INSTRUMENT HOLDER</b> Length 7m	<b>922143</b>
<b>CATTANI Ø21 SUCTION HOLDER</b> Length 5m	<b>922142</b>

**CONFIGURATION OF DOCKS U**

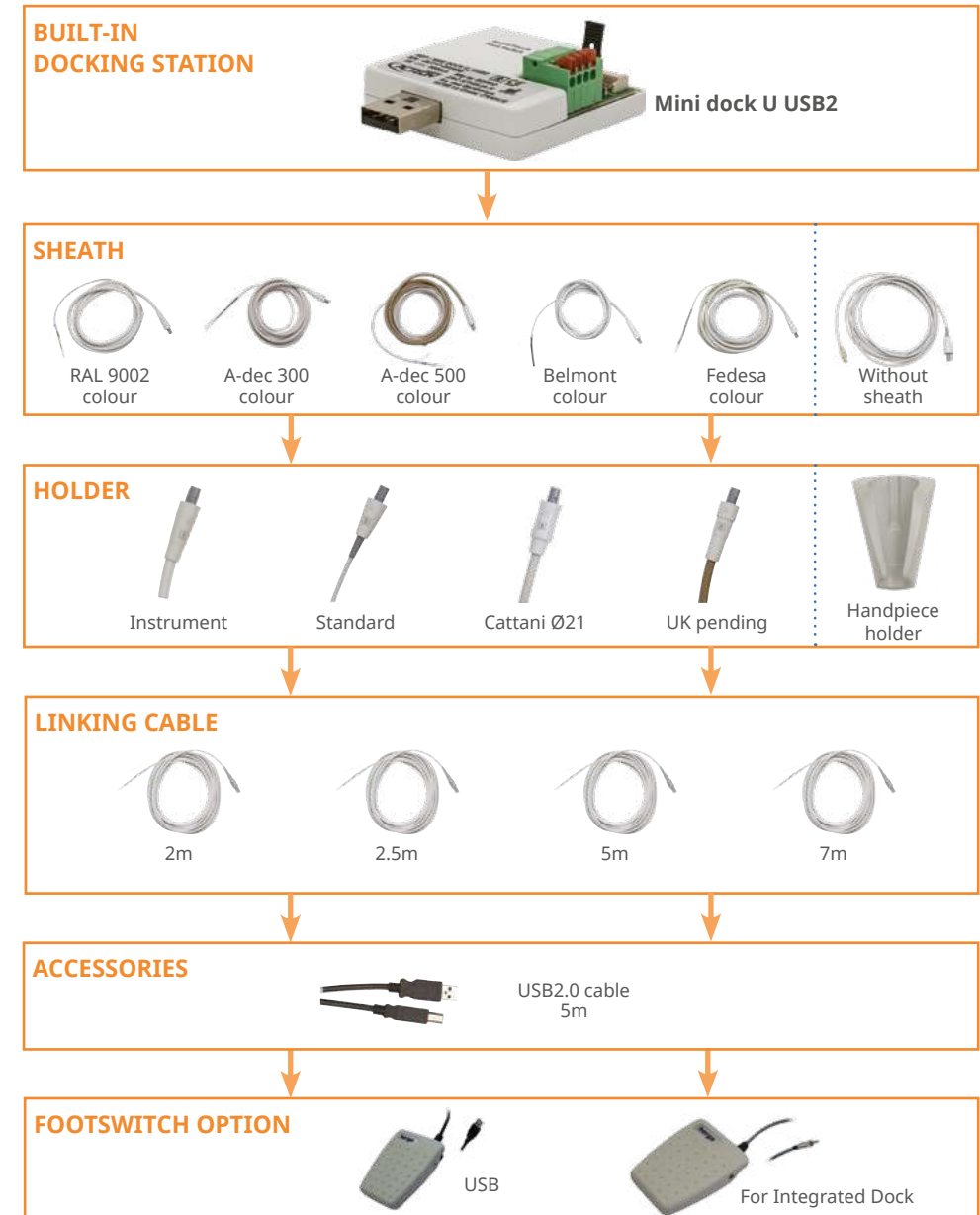

**LINKING CABLES SATELEC®**

<b>INSTRUMENT HOLDER</b> Length 2.5m	<b>922065</b>
<b>INSTRUMENT HOLDER</b> Length 5m	<b>922066</b>
<b>INSTRUMENT HOLDER</b> Length 7m	<b>922067</b>
<b>CATTANI Ø21 SUCTION HOLDER</b> Length 5m	<b>922075</b>
<b>UK PENDING CORD HOLDER</b> Length 2.5m	<b>922086</b>
<b>UK PENDING CORD HOLDER</b> Length 5m	<b>922087</b>
<b>UK PENDING CORD HOLDER</b> Length 7m	<b>922088</b>

**LINKING CABLES ADEC\* 500**

<b>INSTRUMENT HOLDER</b> Length 2m	<b>922098</b>
<b>INSTRUMENT HOLDER</b> Length 5m	<b>922099</b>
<b>INSTRUMENT HOLDER</b> Length 7m	<b>922100</b>
<b>CATTANI Ø21 SUCTION HOLDER</b> Length 2m	<b>922101</b>
<b>CATTANI Ø21 SUCTION HOLDER</b> Length 5m	<b>922102</b>
<b>CATTANI Ø21 SUCTION HOLDER</b> Length 7m	<b>922103</b>
<b>UK PENDING CORD HOLDER</b> Length 2m	<b>922104</b>
<b>UK PENDING CORD HOLDER</b> Length 5m	<b>922105</b>
<b>UK PENDING CORD HOLDER</b> Length 7m	<b>922106</b>

\*Adec is registered trademark

**LINKING CABLES ADEC\* 300**

<b>UK PENDING CORD HOLDER</b> Length 2m	<b>922106</b>
<b>UK PENDING CORD HOLDER</b> Length 7m	<b>922127</b>

**LINKING CABLES BELMONT\* 500**

<b>INSTRUMENT HOLDER</b> Length 2.5m	<b>922068</b>
<b>INSTRUMENT HOLDER</b> Length 5m	<b>922069</b>
<b>INSTRUMENT HOLDER</b> Length 7m	<b>922070</b>
<b>CATTANI Ø21 SUCTION HOLDER</b> Length 2.5m	<b>922080</b>
<b>CATTANI Ø21 SUCTION HOLDER</b> Length 5m	<b>922081</b>
<b>UK PENDING CORD HOLDER</b> Length 7m	<b>922094</b>

**LINKING CABLES FEDESA\* 500**

<b>INSTRUMENT HOLDER</b> Length 2.5m	<b>922071</b>
<b>INSTRUMENT HOLDER</b> Length 5m	<b>922072</b>
<b>INSTRUMENT HOLDER</b> Length 7m	<b>922073</b>
<b>CATTANI Ø21 SUCTION HOLDER</b> Length 5m	<b>922084</b>

\*Adec, Belmont and Fedesa are registered trademark



[www.akteongroup.com](http://www.akteongroup.com)

# ACTEON INFOS

<b>ACTEON® INFOS.....</b>	
Contacts.....	326
Index.....	328
Legal Information .....	330
Quality commitment for greater clinical experience.....	340
Wear guide.....	341

## INFOS &amp; CONTACTS

Contacts

**ACTEON EQUIPMENT & ACTEON PHARMA - FRANCE**

17, av. Gustave Eiffel | ZI du Phare | 33700 MERIGNAC | FRANCE  
 Tel.: +33 (0) 556 340 607 | Fax: +33 (0) 556 349 292 | info@acteongroup.com

**ACTEON IMAGING - FRANCE**

ZAC Athélia IV | Avenue des Genévriers | 13705 LA CIOTAT cedex | FRANCE  
 Tel.: +33 (0) 442 980 101 | Fax: +33 (0) 442 717 690 | info.sop@acteongroup.com

**ACTEON AUSTRALIA / NEW ZEALAND**

Suite 119 | 30-40 Harcourt Parade | Rosebery, NSW 2018 | AUSTRALIA  
 Tel.: +612 9669 2292 | Fax: +612 9669 2204 | info.au@acteongroup.com

**ACTEON BRAZIL - MICRO IMAGEM**

Alameda Venus 233 | D.I American Park | INDAIATUBA, SAO PAULO | CEP 13347-659 | BRAZIL  
 Tel.: +19 3936 8090 | paulo.brienza@acteongroup.com

**ACTEON CHINA**

Office 401 | 12 Xinyuanxili Zhong Street | Chaoyang District | BEIJING 100027 | CHINA  
 Tel.: +86 10 646 57011/2/3 | Fax: +86 10 646 58015 | info.cn@acteongroup.com

**ACTEON GERMANY**

Klaus-Bungert-Str. 5 | 40468 DÜSSELDORF | GERMANY  
 Tel.: +49 211 169800-0 | Fax: +49 211 169800-48 | info.de@acteongroup.com

**ACTEON IBERICA**

Avda Principal n° 11H | Poligono Industrial Can Clapers | 08181 SENTMENAT (BARCELONE) | SPAIN  
 Tel.: +34 93 715 45 20 | Fax: +34 93 715 32 29 | info.es@acteongroup.com

**ACTEON INDIA**

B-94, GIDC Electronic Estate | Sector 25 | GANDHINAGAR 382023 | GUJARAT - INDIA  
 Tel.: +91 1147018291 | Fax: +91 079-23287473 | info@in.acteongroup.com

**ACTEON ITALIA**

Via Roma 45 | 21057 OLGiate OLONA (VARESE) | ITALY  
 Tel.: +39 0331 376 760 | Fax: +39 0331 376 763 | info.it@acteongroup.com

## INFOS &amp; CONTACTS

Contacts

**ACTEON LATIN AMERICA**

Puebla | MEXICO  
 Tel.: +34 93 715 45 20 | Fax: +34 93 715 32 29 | acteon.latam@acteongroup.com

**ACTEON MIDDLE EAST**

247 Wasfi Al Tal Str. | 401 AMMAN | JORDANIA  
 Tel.: +962 6 553 4401 | Fax: +962 6 553 7833 | info.me@acteongroup.com

**ACTEON NORTH AMERICA**

124 Gaither Drive | Suite 140 | MOUNT LAUREL NJ 08054 | UNITED STATES  
 Tel.: +1 856 222 9988 | Fax: +1 856 222 4726 | info.us@acteongroup.com

**ACTEON RUSSIA**

Gilyarovskogo Str. | 6b1, off 212 | 129090 MOSCOW | RUSSIA  
 Tel.: +7 926 233 1695 | Fax: +7 495 150 1323 | info.ru@acteongroup.com

**ACTEON TAIWAN**

Walsin Xinyi Building | 11F, 1 Songzhi Road | TAIPEI 11047 | TAIWAN  
 Tel.: +886 2 8729 2111 | info.tw@acteongroup.com

**ACTEON THAILAND**

23/45 Sorachai Building | 16<sup>th</sup> Floor | Sukumvit 63 Road | Klongton Nua | Wattana, BANGKOK 10110 | THAILAND  
 Tel.: +66 2 714 3295 | Fax: +66 2 714 3296 | info.th@acteongroup.com

**ACTEON TURKEY**

Barbaros Mah. Dereboyu Cad | Akzambak Sokak Uphill Towers | B Blok K14 D84 Atasehir | ISTANBUL 34746 | TURKEY  
 Tel.: +90 532 481 20 57 | talha.gonca@acteongroup.com

**ACTEON UK**

Acteon House | Phoenix park | Eaton Socon | ST NEOTS PE19 8EP | ENGLAND  
 Tel.: +44 1480 477 307 | Fax: +44 1480 477 381 | info.uk@acteongroup.com

# INFOS & CONTACTS

## Contacts

ACTEON® Imaging Suite	20
AirMax	130
Air-N-Go® easy	126
Algina Spray	248
Alginate Mixer	236
Amalgam Instruments	177
Biosplint™ Splitting Ribbons	273
Bliss	163
Bone Chisel	222
Bone Files	223
Bone Splitters	223
Bone Spoon	229
Bone Surgery Kit	79
Burners	241
Burnishers	180
Care Sets	170
Cav-Hycal™	256
Cement Spatulas	181
Chromalg'x™	248
Cimavit™	266
Cimavit™ Photo	266
Cocoon Hygienist LED	145
Coolsin™ Plus	256
Cortisolom™ SP Kit	264
Crest Splitting Kit	84
Crown Extension Kit	83
Curettes	208
Desocclusol™ Orange	267
Dr Roos Periosteal Elevator	193
Edetat	262
Elevators (Extraction)	202
Elevators (Implantology)	231
Endo one Kit	109
EndoCenter	146
Endodontic Tips	104
EndoDual	146
EndoSuccess Apical Surgery Kit	110
EndoSuccess Apical Surgery Tips	105
EndoSuccess CAP Kit	110
EndoSuccess CAP Tips	105
EndoSuccess Retreatment Kit	110
EndoSuccess Retreatment Tips	105
Endosurgery Instruments	196
Endosurgery Kit	196
Endosurgery Tips	104
Essential Kit	86
Etik™ Collagene	270
Eugenol Pur	264
Examination Sets	170
Excavator	181
Excavus Kit	108
Excavus Tips	107
Expasyl™	247
Expasyl™ Exact	246
Extraction Kit	82

Forceps	205
Friljet™	276
GingiProtect	179
Gingival Retraction Instruments	180
Gumak™	255
Haemostatic Forceps	217
Hemostasy™	270
Hycal™	263
Hygiene Kit	108
I-EndoDual	147
I-Surge™	88
I-Surge™ +	89
ImplantCenter™ 2	74
Implantology Tray	232
ImplantProtect Kit (Surgery)	87
ImplantProtect Kit (Ultrasonics)	109
ImplantProtect Tips	103
ImplantRemover Kit	233
Impression Trays	184
Intralift™ Kit	81
Irrisafe Tips	104
Kite Surf™	250
Mallets	228
Micro Mirrors	157
Micro-Retro Newtron® Kit	87
Mini Dock U USB2	318
MiniLED™ Active	139
MiniLED™ OEM	312
MiniLED™ Ortho 2	137
MiniLED™ Standard	138
MiniLED™ Supercharged	136
MiniLED™ Supercharged OEM	313
Motors (OEM)	308
Mouth Mirrors	154
MTA* Caps	263
Needle-Holders (Surgery)	218
Needle-Holders (Implantology)	230
Newtron® Booster	98
Newtron® P5 B.LED	96
Newtron® P5 XS B.LED	94
Newtron® Pack	87
Orthofast™	249
Osteotomes	224
PerfectMargin Rounded Kit	111
PerfectMargin Rounded Tips	106
PerfectMargin Shoulder Kit	111
PerfectMargin Shoulder Tips	106
PerfectMargin Veneers Kit	111
PerfectMargin Veneers Tips	106
Perio Kit	108
Periodontic Tips	102
PerioFine Tips	102
PerioMaintenance Kit (BDR)	109

\* Mineral Trioxide Aggregate

# INFOS & CONTACTS

## Contacts

PerioMaintenance Tips	103
PerioPrecision Kit	109
PerioPrecision Tips	103
PerioSoft Tips	103
Photographic Mirrors	158
Piezocision™ Kit	85
Piezotome® Cube	72
Pliers	237
Pluggers	178
Powders	132
PR Bond™	257
PR Etch™	258
PR Scell™ Glass Ionomer	257
Pralg'x™	249
Primacaine™ 1/100 000	274
Primacaine™ 1/200 000	274
Probes (Diagnostics)	172
Probes (Periodontics)	192
ProphyMax	130
Prosthesis Instruments	186
Prosthesis Tips	107
PSPIX®	38
Quaz®	148
Quick'n Post™	258
Resosolv™	267
Riskontrol®	280
Salvizo™ E.D.T.A.	262
Scalers Instruments	190
Scaling Kit	108
Scaling Tips	102
Scalpels	219
Scissors (Surgery)	212
Scissors (Implantology)	230
Sealing Spatulas & Modelling	176
Sealite™ Regular Kit	265
Septol™ Aspiration	286
Septol™ Empreinte	287
Septol™ Instruments Enzymatic	287
Septol™ Gloves	284
Septol™ Rotative	286
Septol™ Savon Doux	288
Septol™ Spray	289
Servotome®	90
Sinus Lift Instruments	232
Sinus Lift Kit	80
Sitsalicine™	272
Softly	144
Soie Dentaire	271
SOPIX®	46
SOPIX® Inside	46
SOPIX® Inside	48
SOPIX® Inside	48
SOPRO® 617	60
SOPRO® 717 First	58
SOPROCARE®	54
SOPROLIFE®	56

SP 4055 Newtron®	298
SP Newtron®	294
SP Newtron® LED	296
Sterile Dental Needles	277
Sterilization Trays	240
Suni	89
Syndesmotomes	200
Tweezers (Diagnostics)	171
Tweezers (Surgery)	215
Tweezers (Implantology)	229
Trans'Care	145
U-Scan	44
U-Sense	50
U-Sense HD	50
Ultrasonic Cleaners	241
Universal Kit	86
Vela 170	149
Wrenches	112
X-Mind® DC	34
X-Mind® prime PAN	22
X-Mind® prime PAN CEPH	23
X-Mind® prime PAN 3D	24
X-Mind® prime PAN 3D CEPH	25
X-Mind® trium PAN	12
X-Mind® trium PAN 3D	15
X-Mind® trium PAN CEPH	14
X-Mind® trium PAN CEPH 3D	16
X-Mind® trium TLD PAN 3D	18
X-Mind® trium TLD PAN 3D CEPH	19
X-Mind® unity	30
Xylorolland™ avec Adrenaline	275
Xylorolland™ sans vasoconstricteur	275
Xynetic	299

## INFOS &amp; CONTACTS

## Legal Information

**PRIMACAÏNE™****adréline 1/100 000****1- DENOMINATION OF THE MEDICINAL PRODUCT**

PRIMACAÏNE ADRENALINE  
1/100 000, injectable solution for dental use.

**2- QUALITATIVE AND QUANTITATIVE COMPOSITION**

Articaine 60.277 mg in the form of articaine hydrochloride  
Adrenaline 0.017 mg in the form of adrenaline tartrate for one cartridge of 1.7 ml.  
Excipient with a known effect: sodium metabisulphite  
For the complete list of excipients, see section 6.1.

**3- PHARMACEUTICAL FORM**

Injectable solution for dental use.

**4- CLINICAL DATA****4.1 Therapeutic indications**

Local or loco-regional anaesthesia in odonto-stomatological practice. This presentation is particularly adapted when procedures require a high ischemia.

**4.2 Dose and mode of administration**

Reserved for adult and child over 4 as this type of anaesthesia is unsuitable before this age.

**Dose Adult**

The quantity to be injected will be adapted according to the importance of the intervention. Usually, half to one cartridge for a common procedure.  
Do not exceed the dose of 7mg of articaine hydrochloride per kilogram of bodyweight.

**Elderly subject**

Administer half of the dose indicated for adults.

**Pediatric population Child (over 4)**

The quantity to be injected depends on the child's age, weight and the type of procedure performed. The maximal dose to expect is 5mg of articaine hydrochloride (0.125ml of anaesthetic solution) per kilogram of bodyweight. The mean dose in mg of articaine hydrochloride that can be administered in a child can be

calculated as follow: Child's weight (in kilograms) x 1.33

**Mode of administration**

LOCAL OR REGIONAL INTRA-ORAL SUBMUCOSAL INJECTION.

Verify the absence of vascular effraction by repeated aspiration tests, particularly during regional anaesthesia (nerve blocks).

The injection rate must not exceed 1ml of solution per minute.

**4.3 Contraindications**

This medicinal product is contraindicated in the case of hypersensitivity to local anaesthetics or to any of the constituents, and in the following situations:

- Severe disorders of atrioventricular conduction without a pacemaker.
- Epilepsy not controlled by treatment.
- Porphyria.

This medicine is usually unadvised in association with sibutramine (see section 4.5).

**4.4 Special warnings and precautions for use****Special warnings**

THIS PRODUCT CONTAINS 1/100 000 ADRENALINE.

Take the risk of local necrosis into account in hypertensive or diabetic subjects.

Anaesthesiophagy risks: all kind of bites (lips, cheeks, mucous, tongue); advise patients to avoid the use of chewing gum or eating food as long as the insensibility persists.

Avoid injection into infected and inflamed areas (decreased efficacy of the local anaesthetic).

Sportsmen will be advised that this medicinal product contains an active substance that can cause a positive reaction on anti-doping control tests.

**Pediatric population**

The use of this product is not recommended in children under the age of 4 years, as this type of anaesthesia is unsuitable before this age.

**Precautions for use**

The use of this product requires imperatively:

- to conduct a clinical interview to determine the clinical context,

concomitant treatments and the patient's history,

- to perform a test injection of 5 to 10% of the dose in case of allergic risk,
- to perform the injection slowly and strictly outside of the vessels, verifying by repeated aspirations,
- to maintain verbal contact with the patient.

Increased surveillance is required in subjects treated with anticoagulants (surveillance of the INR).

Due to the presence of adrenaline, precautions and increased surveillance in case of:

- all rhythm abnormalities, except bradycardia;
- coronary insufficiency;
- severe arterial hypertension.

The dose of articaine may need to be decreased in case of severe hepatic insufficiency, due to the mainly hepatic metabolism of amide local anaesthetics.

The dosage must also be decreased in case of hypoxia, hyperkalaemia or metabolic acidosis.

The simultaneous administration of this anaesthetic with some products (see section 4.5) requires a close monitoring of the patient's clinical and biological state.

**4.5 Interactions with other drugs or other interactions****Association not recommended**

Due to the presence of adrenaline:

**+ Sibutramine:** Paroxystic hypertension with possibility of rhythm abnormalities (inhibition of the adrenaline or nor-adrenaline's entrance in the sympathetic fibre).

**Associations with precautions for use**

Due to the presence of adrenaline:

**+ Halogenated volatile anaesthetics:** Serious ventricular rhythm abnormalities (increase of the cardiac reactivity). Limit the dose, for example: less than 0.1mg of adrenaline in 10 minutes or 0.3mg in one hour in adult.

**+ Imipraminic anti-depressors:** Paroxystic hypertension with possibility of rhythm abnormalities (inhibition of the adrenaline or nor-adrenaline's entrance in the sympathetic fibre). Limit the dose,

## INFOS &amp; CONTACTS

## Legal Information

for example: less than 0.1 mg of adrenaline in 10 minutes or 0.3mg in one hour in adult.

**+ Serotonergic-noradrenergic anti-depressors (described for minalcipran and venlafaxine):** Paroxystic hypertension with possibility of rhythm abnormalities (inhibition of the adrenaline or nor-adrenaline's entrance in the sympathetic fibre). Limit the dose, for example: less than 0.1 mg of adrenaline in 10 minutes or 0.3mg in one hour in adult.

**+ Non selective MAOI (iproniazide):**

Increase of the adrenaline and nor-adrenaline's pressive action, more often moderated. Use only under strict medicinal control.

**+ "A" Selective MAOI (moclobemide, tolaxatone) by extrapolation from the non selective MAOI:**

Risk of increase of the pressive action. Use only under strict medicinal control.

**Associations to take into account**

**+ Guanethidine:** High increase of the blood pressure (hyper reactivity due to the reduction of the sympathetic tonus and/or to the inhibition of the adrenaline or nor-adrenaline's entrance in the sympathetic fibre).

**4.6 Fertility, pregnancy and breastfeeding****Pregnancy**

The studies carried out on animals do not show any teratogenic effect. Due to the absence of teratogenic effect on mankind is not expected. Indeed, until today, the substances responsible of malformations on mankind have been teratogenics on animals during studies carried out on two species.

In clinical practice, there are actually not enough relevant facts to estimate an eventual malformative or foetotoxic effect of the articaine when administered during pregnancy.

Consequently, the use of articaine can be prescribed for odonto-stomatology indications during pregnancy, only if necessary.

**Breastfeeding**

Like other local anaesthetics, articaine diffuses into breast milk in very small quantities; however, breastfeeding can be continued following the anaesthetic procedure.

**4.7 Effects on ability to drive and use machines**

PRIMACAÏNE ADRENALINE 1/100 000 has a moderate influence on the ability to drive and use machines.

**4.8 Side effects**

Like with all the anaesthetics used in odonto-stomatology, lipothymies can happen.

This product contains sodium metabisulphite, which can involve or worsen anaphylactic reactions and bronchospasms.

In the case of overdose or in certain predisposed patients, the following clinical signs may be observed:

- on the central nervous system: nervousness, agitation, yawning, tremor, apprehension, nystagmus, logorrhoea, headache, nausea, ringing in the ears. In the presence of these warning signs, the patient must be asked to hyperventilate, and attentive surveillance is required to prevent possible deterioration with seizures followed by CNS depression.

- on the respiratory system: tachypnoea, then bradypnoea, possibly leading to apnoea.

- on the cardiovascular system: tachycardia, bradycardia, cardiovascular depression with arterial hypotension, possibly leading to collapse, arrhythmias (premature ventricular complexes, ventricular fibrillation), disorders of conduction (atrioventricular block).

These cardiac manifestations can lead to cardiac arrest.

**Reporting of suspected side effects**

The reporting of suspected side effects after approval of the medicinal product is important. It allows continuous monitoring of the benefit/risk ratio of the medicinal product.  
Health professionals declare any

suspected side effects through the national reporting system.

**4.9 Overdose**

Toxic reactions, reflecting overdose of local anaesthetic, can occur in two situations: either immediately, due to relative overdose resulting from accidental intravenous injection, or more delayed, corresponding to true overdose due to the use of an excessive quantity of anaesthetic.

**Action in case of overdose**

As soon as warning signs are observed, ask the patient to hyperventilate, place the patient in the supine position, when necessary. In the case of clonic seizures, oxygenation injection of a benzodiazepine.

Treatment may require intubation with assisted ventilation.

**5- PHARMACOLOGICAL PROPERTIES**

**5.1 Pharmacodynamic properties**  
Pharmacotherapeutic class: **LOCAL ANAESTHETICS**,  
ATC Code: **N01BB58**

**Mechanism of action**

Articaine hydrochloride is an amide local anaesthetic, which blocks propagation of the nerve impulse along the nerve fibre at the site of injection.

The addition of adrenaline (diluted at 1/100 000) to the solution of articaine delays the passage of the articaine into the systemic circulation and maintains an active tissue concentration, allowing to obtain a little hemorrhagic operative field.

Anaesthesia is obtained within 2 to 3 minutes. The duration of anaesthesia allowing the surgical procedure is about 60 minutes. It is 2 to 3 times shorter for pulpar anaesthesia.

**5.2 Pharmacokinetic properties Distribution**

When injected into the oral mucosa, articaine reaches its peak blood concentration about 30 minutes after injection.

**Elimination**

The mean elimination half-life of articaine hydrochloride is about 110 minutes.



## INFOS &amp; CONTACTS

## Legal Information

Articaine hydrochloride is mainly metabolised in the liver; 5 to 10% of the dose are eliminated under unchanged form in the urine.

**5.3 Preclinical safety data**

Studies carried out on animals have demonstrated the good tolerance of articaine.

Like other amide local anaesthetics, high doses of the active substance can induce toxic reactions on the central nervous system and/or on the cardiovascular system (see section 4.8).

**6- PHARMACEUTICAL DATA****6.1 List of excipients**

Sodium chloride, sodium metabisulphite, hydrochloric acid, sodium hydroxide, water for injections.

**6.2 Incompatibilities**

In the absence of compatibility studies, this medicinal product should not be mixed with other medicinal products.

**6.3 Shelf life**

Before opening: 2 years.

After opening: the product must be used immediately.

**6.4 Special storage precautions**

Store at a temperature not exceeding + 25°C.

Store cartridges in the external packaging, away from light.

**6.5 Nature and content of external packing**

1.7ml in cartridge (type I colourless glass) with a stopper (bromobutyl) and capsule (aluminium) with joint (bromobutyl). Box of 50.

**6.6 Special precautions for disposal and handling**

Like for all cartridges, the diaphragm will be disinfected just before use. It will be carefully plugged:

- either with ethyl alcohol at 70%,
- or with pure isopropyl alcohol at 90% for pharmaceutical use.

The cartridges must never be plunged in any solution.

Do not mix the injectable solution with other products in the same syringe.

Any opened cartridge of anaesthetic solution must not be re-used.

**7- HOLDER OF THE MARKETING AUTHORIZATION**

PRODUITS DENTAIRE PIERRE ROLLAND

ZI du Phare - 17 avenue Gustave Eiffel - 33700 MERIGNAC

**8- FRENCH REGISTRATION ID NUMBER**

CIP 34009 564 696 5 9: 1.7ml in cartridge (glass) with a stopper (bromobutyl); box of 50.

**9- DATE OF FIRST AUTHORIZATION/OF RENEWAL OF THE AUTHORIZATION IN FRANCE**

Date of first authorization:

24<sup>th</sup> December 2002

Date of last renewal:

24<sup>th</sup> December 2012

**10- DATE OF TEXT UP-DATING IN FRANCE**

24<sup>th</sup> January 2019

**CONDITIONS OF PRESCRIPTION AND DELIVERY IN FRANCE**

List I.

Medicinal product reserved for professional use according to article R.5121-80 of the French public health code.

**PRIMACAÏNE™****adrénaline 1/200 000****1- DENOMINATION OF THE MEDICINAL PRODUCT**

PRIMACAÏNE ADRENALINE 1/200 000, injectable solution for dental use.

**2- QUALITATIVE AND QUANTITATIVE COMPOSITION**

Articaine 60.277 mg in the form of articaine hydrochloride  
Adrenaline 0.0085 mg in the form of adrenaline tartrate for one cartridge of 1.7 ml.  
Excipient with a known effect: sodium metabisulphite  
For the complete list of excipients, see section 6.1.

**3- PHARMACEUTICAL FORM**

Injectable solution for dental use.

**4- CLINICAL DATA****4.1 Therapeutic indications**

Local or loco-regional anaesthesia in odonto-stomatological practice.

**4.2 Dose and mode of administration**

Reserved for adult and child over 4 as this type of anaesthesia is unsuitable before this age.

**Dose****Adult**

The quantity to be injected will be adapted according to the importance of the intervention. Usually, half to one cartridge for a common procedure.

Do not exceed the dose of 7mg of articaine hydrochloride per kilogram of bodyweight.

**Elderly subject**

Administer half of the dose indicated for adults.

**Pediatric population****Child (over 4)**

The quantity to be injected depends on the child's age, weight and the type of procedure performed.

The maximal dose to expect is 5mg of articaine hydrochloride (0.125ml of anaesthetic solution) per kilogram of bodyweight.

The mean dose in mg of articaine hydrochloride that can be administered in a child can be calculated as follow: Child's weight (in kilograms) x 1.33

## INFOS &amp; CONTACTS

## Legal Information

**Mode of administration**

LOCAL OR REGIONAL INTRA-ORAL SUBMUCOSAL INJECTION.

Verify the absence of vascular effraction by repeated aspiration tests, particularly during regional anaesthesia (nerve blocks).

The injection rate must not exceed 1ml of solution per minute.

**4.3 Contraindications**

This medicinal product is contraindicated in the case of hypersensitivity to local anaesthetics or to any of the constituents, and in the following situations:

- Severe disorders of atrioventricular conduction without a pacemaker.
- Epilepsy not controlled by treatment
- Porphyria.

This medicine is usually unadvised in association with sibutramine (see section 4.5).

**4.4 Special warnings and precautions for use****Special warnings**

THIS PRODUCT CONTAINS 1/200 000 ADRENALINE.

Take the risk of local necrosis into account in hypertensive or diabetic subjects.

Anaesthesiophagy risks: all kind of bites (lips, cheeks, mucous, tongue); advise patients to avoid the use of chewing gum or eating food as long as the insensibility persists.

Avoid injection into infected and inflamed areas (decreased efficacy of the local anaesthetic).

Sportsmen will be advised that this medicinal product contains an active substance that can cause a positive reaction on anti-doping control tests.

**Pediatric population**

The use of this product is not recommended in children under the age of 4 years, as this type of anaesthesia is unsuitable before this age.

**Precautions for use**

The use of this product requires imperatively:

- to conduct a clinical interview to determine the clinical context, concomitant treatments and the patient's history,

- to perform a test injection of 5 to 10% of the dose in case of allergic risk,

- to perform the injection slowly and strictly outside of the vessels, verifying by repeated aspirations,
- to maintain verbal contact with the patient.

Increased surveillance is required in subjects treated with anticoagulants (surveillance of the INR).

Due to the presence of adrenaline, precautions and increased surveillance in case of:

- all rhythm abnormalities, except bradycardia;
  - coronary insufficiency;
  - severe arterial hypertension.
- The dose of articaine may need to be decreased in case of severe hepatic insufficiency, due to the mainly hepatic metabolism of amide local anaesthetics.

The dosage must also be decreased in case of hypoxia, hyperkalaemia or metabolic acidosis.

The simultaneous administration of this anaesthetic with some products (see section 4.5) requires a close monitoring of the patient's clinical and biological state.

**4.5 Interactions with other drugs or other interactions****Associations not recommended**

Due to the presence of adrenaline:

- + **Sibutramine:** Paroxystic hypertension with possibility of rhythm abnormalities (inhibition of the adrenaline or nor-adrenaline's entrance in the sympathetic fibre).

**Association with precautions for use**  
Due to the presence of adrenaline:

- + **Halogenated volatile anaesthetics:** Serious ventricular rhythm abnormalities (increase of the cardiac reactivity). Limit the dose, for example: less than 0.1mg of adrenaline in 10 minutes or 0.3mg in one hour in adult.

- + **Imipraminic anti-depressors:** Paroxystic hypertension with possibility of rhythm abnormalities (inhibition of the adrenaline or nor-adrenaline's entrance in the sympathetic fibre).

Limit the dose, for example: less than 0.1mg of adrenaline in 10 minutes or 0.3mg in one hour in adult.

+ **Serotonergic-noradrenergic anti-depressors (described for minalcipran and venlafaxine):**

Paroxystic hypertension with possibility of rhythm abnormalities (inhibition of the adrenaline or nor-adrenaline's entrance in the sympathetic fibre). Limit the dose, for example: less than 0.1mg of adrenaline in 10 minutes or 0.3mg in one hour in adult.

+ **Non selective MAOI**

(iproniazide): Increase of the adrenaline and nor-adrenaline's pressive action, more often moderated. Use only under strict medicinal control.

+ **"A" Selective MAOI** (moclobemide, tolaxatone) by extrapolation from the non selective MAOI: Risk of increase of the pressive action. Use only under strict medicinal control.

**Associations to take into account**

+ **Guanethidine:** High increase of the blood pressure (hyper reactivity due to the reduction of the sympathetic tonus and/or to the inhibition of the adrenaline or nor-adrenaline's entrance in the sympathetic fibre).

**4.6 Fertility, pregnancy and breastfeeding****Pregnancy**

The studies carried out on animals do not show any teratogenic effect. Due to the absence of teratogenic effect on animals, a malformative effect on mankind is not expected. Indeed, until today, the substances responsible of malformations on mankind have been teratogenics on animals during studies carried out on two species.

In clinical practice, there are actually not enough relevant facts to estimate an eventual malformative or foetotoxic effect of the articaine when administered during pregnancy.

Consequently, the use of articaine can be prescribed for odonto-stomatology indications during pregnancy, only if necessary.

## INFOS &amp; CONTACTS

## Legal Information

**Breastfeeding**

Like other local anaesthetics, articaine diffuses into breast milk in very small quantities; however, breastfeeding can be continued following the anaesthetic procedure.

**4.7 Effects on ability to drive and use machines**

PRIMACAINE ADRENALINE 1/200 000 has a moderate influence on the ability to drive and use machines.

**4.8 Side effects**

Like with all the anaesthetics used in odonto-stomatology, lipothymies can happen.

This product contains sodium metabisulphite, which can involve or worsen anaphylactic reactions and bronchospasms.

In the case of overdose or in certain predisposed patients, the following clinical signs may be observed:

- **on the central nervous system:** nervousness, agitation, yawning, tremor, apprehension, nystagmus, logorrhoea, headache, nausea, ringing in the ears. In the presence of these warning signs, the patient must be asked to hyperventilate, and attentive surveillance is required to prevent possible deterioration with seizures followed by CNS depression.
- **on the respiratory system:** tachypnoea, then bradypnoea, possibly leading to apnoea.
- **on the cardiovascular system:** tachycardia, bradycardia, cardiovascular depression with arterial hypotension, possibly leading to collapse, arrhythmias (premature ventricular complexes, ventricular fibrillation), disorders of conduction (atrioventricular block).

These cardiac manifestations can lead to cardiac arrest.

**Reporting of suspected side effects**

The reporting of suspected side effects after approval of the medicinal product is important. It allows continuous monitoring of the benefit/risk ratio of the medicinal product.

Health professionals declare any

suspected side effects through the national reporting system.

**4.9 Overdose**

Toxic reactions, reflecting overdose of local anaesthetic, can occur in two situations: either immediately, due to relative overdose resulting from accidental intravenous injection, or more delayed, corresponding to true overdose due to the use of an excessive quantity of anaesthetic.

**Action in case of overdose**

As soon as warning signs are observed, ask the patient to hyperventilate, place the patient in the supine position, when necessary. In the case of clonic seizures, oxygenation injection of a benzodiazepine.

Treatment may require intubation with assisted ventilation.

**5- PHARMACOLOGICAL PROPERTIES****5.1 Pharmacodynamic properties**

Pharmacotherapeutic class: **LOCAL ANAESTHETICS**,  
ATC Code: **N01BB58**

**Mechanism of action**

Articaine hydrochloride is an amide local anaesthetic, which blocks propagation of the nerve impulse along the nerve fibre at the site of injection.

The addition of adrenaline (diluted at 1/200 000) to the solution of articaine delays the passage of the articaine into the systemic circulation and maintains an active tissue concentration, allowing to obtain a little hemorrhagic operative field.

Anaesthesia is obtained within 2 to 3 minutes. The duration of anaesthesia allowing the surgical procedure is about 60 minutes. It is 2 to 3 times shorter for pulpar anaesthesia.

**5.2 Pharmacokinetic properties**

**Distribution**  
When injected into the oral mucosa, articaine reaches its peak blood concentration about 30 minutes after injection.

**Elimination**

The mean elimination half-life of articaine hydrochloride is about 110 minutes.

Articaine hydrochloride is mainly metabolised in the liver; 5 to 10% of the dose are eliminated under unchanged form in the urine.

**5.3 Preclinical safety data**

Studies carried out on animals have demonstrated the good tolerance of articaine. Like other amide local anaesthetics, high doses of the active substance can induce toxic reactions on the central nervous system and/or on the cardiovascular system (see section 4.8).

**6- PHARMACEUTICAL DATA****6.1 List of excipients**

Sodium chloride, sodium metabisulphite, hydrochloride acid, sodium hydroxide, water for injections.

**6.2 Incompatibilities**

In the absence of compatibility studies, this medicinal product should not be mixed with other medicinal products.

**6.3 Shelf life**

Before opening: 2 years.  
After opening: the product must be used immediately.

**6.4 Special storage precautions**

Store at a temperature not exceeding + 25°C.  
Store cartridges in the external packaging, away from light.

**6.5 Nature and content of external packing**

1.7ml in cartridge (type I colourless glass) with a stopper (bromobutyl) and capsule (aluminium) with joint (bromobutyl). Box of 50.

**6.6 Special precautions for disposal and handling**

Like for all cartridges, the diaphragm will be disinfected just before use. It will be carefully plugged:

- either with ethyl alcohol at 70%,
- or with pure isopropyl alcohol at 90% for pharmaceutical use.

The cartridges must never be plunged in any solution. Do not mix the injectable solution with other products in the same syringe.

Any opened cartridge of anaesthetic solution must not be re-used.

## INFOS &amp; CONTACTS

## Legal Information

**7- HOLDER OF THE MARKETING AUTHORIZATION**

PRODUITS DENTAIRES PIERRE ROLLAND

ZI du Phare - 17 avenue Gustave Eiffel - 33700 MERIGNAC

**8- FRENCH REGISTRATION ID NUMBER**

CIP 34009 564 697 1 0: 1.7ml in cartridge (glass) with a stopper (bromobutyl); box of 50.

**9- DATE OF FIRST AUTHORIZATION/OF RENEWAL OF THE AUTHORIZATION IN FRANCE**

Date of first authorization:

24<sup>th</sup> December 2002

Date of last renewal:

24<sup>th</sup> December 2012

**10- DATE OF TEXT UP-DATING IN FRANCE**

12<sup>th</sup> February 2019

**CONDITIONS OF PRESCRIPTION AND DELIVERY IN FRANCE**

List I.

Medicinal product reserved for professional use according to article R.5121-80 of the French public health code.

**XYLOROLLAND™****sans vasoconstricteur****1- DENOMINATION OF THE MEDICINAL PRODUCT**

XYLOROLLAND SANS VASOCONSTRICTEUR, injectable solution for dental use.

**2- QUALITATIVE AND QUANTITATIVE COMPOSITION**

Lidocaine hydrochloride 36,00000mg

for one cartridge containing 1.8ml. The sodium metabisulphite content, expressed as sulphur anhydride, is 1.8mg per ampoule.

Excipient with a known effect: sodium metabisulphite

For the complete list of excipients, see section 6.1.

**3- PHARMACEUTICAL FORM**

Injectable solution for dental use.

**4- CLINICAL DATA****4.1 Therapeutic indications**

Local or loco-regional anaesthesia in odonto-stomatological practice.

This preparation is particularly used when the administration of a vasoconstrictor is inadvisable.

**4.2 Dose and mode of administration**

Reserved for adult and child over 4 as this type of anaesthesia is unsuitable before this age.

**Dose****Adult**

The quantity to be injected will be adapted according to the importance of the intervention.

Do not exceed the dose of 300mg of lidocaine hydrochloride per session.

**Elderly subject**

Administer half of the dose indicated for adults.

**Pediatric population****Child (over 4)**

The quantity to be injected depends on the child's age, weight and the type of procedure performed.

The maximum dose to predict is 20 to 30mg of lidocaine hydrochloride per session.

Do not exceed 2.2mg of lidocaine hydrochloride per kilogram of body weight.

**Mode of administration**

LOCAL OR REGIONAL INTRA-ORAL SUBMUCOSAL INJECTION.

Verify the absence of vascular effraction by repeated aspiration tests, particularly during regional anaesthesia (nerve blocks).

The injection rate must not exceed 1ml of solution per minute.

**4.3 Contraindications**

This medicinal product is contraindicated in the case of hypersensitivity to local anaesthetics or to any of the constituents, and in the following situations:

- Severe disorders of atrioventricular conduction without a pacemaker.
- Epilepsy not controlled by treatment
- Intermittent acute porphyria.

**4.4 Special warnings and precautions for use****Special warnings**

Anaesthesiophagy risks: all kind of bites (lips, cheeks, mucous, tongue); advise patients to avoid the use of chewing gum or eating food as long as the insensibility persists.

Avoid injection into infected and inflamed areas (decreased efficacy of the local anaesthetic).

Sportsmen will be advised that this medicinal product contains an active substance that can cause a positive reaction on anti-doping control tests.

**Pediatric population**

The use of this product is not recommended in children under the age of 4 years, as this type of anaesthesia is unsuitable before this age.

**Precautions for use**

The use of this product requires imperatively:

- to conduct a clinical interview to determine the clinical context, concomitant treatments and the patient's history;
- to perform a test injection of 5 to 10% of the dose in case of allergic risk,
- to perform the injection slowly and strictly outside of the vessels, verifying by repeated aspirations,
- to maintain verbal contact with the patient.

Increased surveillance is required in subjects treated with anticoagulants (surveillance of the INR).

Doses of lidocaine may need to be decreased in the case of severe hepatic insufficiency, due to the mainly hepatic metabolism of amide local anaesthetics.

The dosage must also be decreased in the case of hypoxia, hyperkalaemia or metabolic acidosis.

#### 4.5 Interactions with other drugs or other interactions

Not applicable.

#### 4.6 Fertility, pregnancy and breastfeeding

##### Pregnancy

No reliable animal teratogenesis data are available.

In clinical practice, analysis of a large number of pregnancies exposed to lidocaine did not reveal any particular foetotoxic or malformative effect for lidocaine. However, only epidemiological studies can confirm the absence of risk.

Consequently, the use of lidocaine can be prescribed for odonto-stomatology indications during pregnancy, only if necessary.

##### Breastfeeding

Like other local anaesthetics, lidocaine diffuses into breast milk in very small quantities; however, breastfeeding can be continued following the anaesthetic procedure.

#### 4.7 Effects on ability to drive and use machines

XYLOROLLAND SANS VASOCONSTRICTEUR has a moderate influence on the ability to drive and use machines.

#### 4.8 Side effects

Due to the presence of sodium metabisulphite, risk of allergic reactions, as well as anaphylactic reactions and bronchospasms. Like with all the anaesthetics used in odonto-stomatology, lipothymies can happen.

In the case of overdose or in certain predisposed patients, the following clinical signs may be observed:

- on the central nervous system: nervousness, agitation, yawning, tremor, apprehension, nystagmus, logorrhoea, headache, nausea, ringing in the ears. In the presence of these warning signs, the patient must be asked to hyperventilate, and attentive surveillance is required to prevent possible deterioration with seizures followed by CNS depression.
- on the respiratory system: tachypnoea, then bradypnoea, possibly leading to apnoea.
- on the cardiovascular system: tachycardia, bradycardia, cardiovascular depression with arterial hypotension, possibly leading to collapse, arrhythmias (premature ventricular complexes, ventricular fibrillation), disorders of conduction (atrioventricular block).

These cardiac manifestations can lead to cardiac arrest.

#### Reporting of suspected side effects

The reporting of suspected side effects after approval of the medicinal product is important. It allows continuous monitoring of the benefit/risk ratio of the medicinal product. Health professionals declare any suspected side effects through the national reporting system.

#### 4.9 Overdose

Toxic reactions, reflecting overdose of local anaesthetic, can occur in two situations: either immediately, due to relative overdose resulting from accidental intravenous injection, or more delayed, corresponding to true overdose due to the use of an excessive quantity of anaesthetic.

#### Action in case of overdose

As soon as warning signs are observed, ask the patient to hyperventilate, place the patient in the supine position, when necessary. In the case of clonic seizures, oxygenation injection of a benzodiazepine.

Treatment may require intubation with assisted ventilation.

## 5- PHARMACOLOGICAL PROPERTIES

### 5.1 Pharmacodynamic properties

Pharmacotherapeutic class: **LOCAL ANAESTHETICS**,

ATC Code: **N01BB02**

#### Mechanism of action

Lidocaine hydrochloride is an amino-amide local anaesthetic, which blocks propagation of the nerve impulse along the nerve fibre at the site of injection.

Anaesthesia is obtained within 2 to 3 minutes. The duration of anaesthesia allowing the surgical procedure is about 90 to 120 minutes and 5 to 10 minutes on the pulp.

### 5.2 Pharmacokinetic properties

#### Distribution

When injected into the oral mucosa, lidocaine reaches a peak blood concentration about 10 to 15 minutes after injection.

#### Elimination

The mean elimination half-life of lidocaine hydrochloride is about 90 minutes.

Lidocaine hydrochloride is mainly metabolised in the liver; 5 to 10% of the dose are eliminated under unchanged form in the urine.

### 5.3 Preclinical safety data

Studies carried out on animals have demonstrated the good tolerance of lidocaine. Like other amide local anaesthetics, high doses of the active substance can induce toxic reactions on the central nervous system and/or on the cardiovascular system (see section 4.8).

## 6- PHARMACEUTICAL DATA

### 6.1 List of excipients

Sodium chloride, sodium metabisulphite, sodium hydroxide, water for injections.

Inertizing gas: nitrogen

### 6.2 Incompatibilities

In the absence of compatibility studies, this medicinal product should not be mixed with other medicinal products.

### 6.3 Shelf life

Before opening: 3 years.

After opening: the product must be used immediately.

### 6.4 Special storage precautions

Store at a temperature below +25°C and away from light.

## 6.5 Nature and content of external packing

1.8ml in cartridge (type I colourless glass) with a stopper (bromobutyl) and capsule (aluminium) with joint (bromobutyl). Box of 50.

## 6.6 Special precautions for disposal and handling

Like for all cartridges, the diaphragm will be disinfected just before use. It will be carefully plugged:

- either with ethyl alcohol at 70%,
- or with pure isopropyl alcohol at 90% for pharmaceutical use.

The cartridges must never be plunged in any solution.

Do not mix the injectable solution with other products in the same syringe.

Any opened cartridge of anaesthetic solution must not be re-used.

## 7- HOLDER OF THE MARKETING AUTHORIZATION

PRODUITS DENTAIRES PIERRE

ROLLAND

ZI du Phare - 17 avenue Gustave

Eiffel - 33700 MERIGNAC

## 8- FRENCH REGISTRATION ID NUMBER

CIP 34009 500 219 1 4: 1.8ml in cartridge (glass) with a stopper (bromobutyl); box of 50.

## 9- DATE OF FIRST AUTHORIZATION/OFF RENEWAL OF AUTHORIZATION IN FRANCE

Date of first authorization: 18<sup>th</sup> September 1997

Date of last renewal: 18<sup>th</sup> September 2007

## 10- DATE OF TEXT UP-DATING IN FRANCE

19<sup>th</sup> February 2019

## CONDITIONS OF PRESCRIPTION AND DELIVERY IN FRANCE

List II

Medicinal product reserved for professional use according to article R.5121-80 of the French public health code.

## XYLOROLLAND™

### avec adrénaline

**1- DENOMINATION OF THE MEDICINAL PRODUCT**  
XYLOROLLAND AVEC ADRENALINE, injectable solution for dental use.

## 2- QUALITATIVE AND QUANTITATIVE COMPOSITION

Lidocaine hydrochloride 36,00000mg  
Adrenaline tartrate 0,04086mg as adrenaline 0,02250mg for one cartridge containing 1.8ml. Excipient with a known effect: sodium metabisulphite  
For the complete list of excipients, see section 6.1.

## 3- PHARMACEUTICAL FORM

Injectable solution for dental use.

## 4- CLINICAL DATA

### 4.1 Therapeutic indications

Local or loco-regional anaesthesia in odonto-stomatological practice.

### 4.2 Dose and mode of administration

Reserved for adult or children over 4 as this type of anaesthesia is unsuitable before this age.

### Dose

#### Adult

The quantity to be injected will be adapted according to the importance of the intervention. Usually, half to one cartridge for a common procedure. Do not exceed the dose of 300mg of lidocaine hydrochloride per kilogram of bodyweight.

#### Elderly subject

Administer half of the dose indicated for adults.

#### Pediatric population

##### Child (over 4)

The quantity to be injected depends on the child's age, weight and the type of procedure performed. The maximum dose to predict is 20 to 30mg of lidocaine hydrochloride per session.

The maximal dose in mg of lidocaine hydrochloride that can be administered in a child can be calculated as follow: child's weight (in kilo) x 1.33

Do not exceed 2.2mg of lidocaine hydrochloride per kilogram of bodyweight.

## Mode of administration

LOCAL OR REGIONAL INTRA-ORAL SUBMUCOSAL INJECTION.

Verify the absence of vascular effraction by repeated aspiration tests, particularly during regional anaesthesia (nerve blocks).

The injection rate must not exceed 1ml of solution per minute.

## 4.3 Contraindications

This medicinal product is contraindicated in the case of hypersensitivity to local anaesthetics or to any of the constituents, and in the following situations:

- Severe disorders of atrioventricular conduction without a pacemaker.
- Epilepsy not controlled by treatment

• Intermittent acute porphyria.

This medicinal product is usually unadvised in association with some medicinal products like guanethidine and related substances (see section 4.5).

## 4.4 Special warnings and precautions for use

### Special warnings

THIS PRODUCT CONTAINS ADRENALINE.

Take the risk of local necrosis into account in hypertensive or diabetic subjects.

Anaesthesiophagy risks: all kind of bites (lips, cheeks, mucous, tongue); advise patients to avoid the use of chewing gum or eating food as long as the insensibility persists.

Avoid injection into infected and inflamed areas (decreased efficacy of the local anaesthetic).

Sportsmen will be advised that this medicinal product contains an active substance that can cause a positive reaction on anti-doping control tests.

### Pediatric population

The use of this product is not recommended in children under the age of 4 years, as this type of anaesthesia is unsuitable before this age.



**Precautions for use**

The use of this product requires **imperatively**:

- to conduct a clinical interview to determine the clinical context, concomitant treatments and the patient's history,
- to perform a test injection of 5 to 10% of the dose in case of allergic risk,
- to perform the injection slowly and strictly outside of the vessels, verifying by repeated aspirations,
- to maintain verbal contact with the patient.

Increased surveillance is required in subjects treated with anticoagulants (surveillance of the INR).

Due to the presence of adrenaline, precautions and increased surveillance in the following cases:

- all rhythm abnormalities, except bradycardia,
  - coronary insufficiency,
  - severe arterial hypertension.
- The dose of lidocaine may need to be decreased in the case of severe hepatocellular insufficiency, due to the mainly hepatic metabolism of amide local anaesthetics. The dose must also be decreased in the case of hypoxia, hyperkalaemia or metabolic acidosis. The simultaneous administration of this anaesthetic with some products (see section 4.5) requires a close monitoring of the patient's clinical and biological state.

**4.5 Interactions with other drugs or other interactions****Associations not recommended**

Due to the presence of adrenaline: **+ Guanethidine and related substances** (for the treatment of glaucoma): High increase of the blood pressure (hyper reactivity due to the reduction of the sympathetic tonus and/or to the inhibition of the adrenaline's entrance in the sympathetic fibrous). If the association cannot be avoided, use with care lower doses of sympathomimetics (adrenaline).

**Associations with precautions for use**

Due to the presence of adrenaline:

**+ Halogenated volatile**

**anaesthetics:** Serious ventricular rhythm abnormalities (increase of the cardiac reactivity).

Precautions for use: Limit the dose, for example: less than 0.1mg of adrenaline in 10 minutes or 0.3mg in one hour in adult.

**+ Imipraminic anti-depressors:**

Paroxysmic hypertension with possibility of rhythm abnormalities (inhibition of the adrenaline or nor-adrenaline's entrance in the sympathetic fibrous).

Precautions for use: Limit the dose, for example: less than 0.1mg of adrenaline in 10 minutes or 0.3mg in one hour in adult.

**+ Serotonergic-noradrenergic anti-depressors (described for minalcipran and venlafaxine):**

Paroxysmic hypertension with possibility of rhythm abnormalities (inhibition of the adrenaline or nor-adrenaline's entrance in the sympathetic fibrous).

Precautions for use: Limit the dose, for example: less than 0.1mg of adrenaline in 10 minutes or 0.3mg in one hour in adult.

**+ Non selective MAOI**

**(iproniazide):** Increase of the adrenaline's pressive action, more often moderated. Use only under strict medicinal control.

**+ "A" Selective MAOI (moclobemide, tolloxatone) by extrapolation from the non selective MAOI:**

Risk of increase of the pressive action. Use only under strict medicinal control.

**4.6 Fertility, pregnancy and breastfeeding**

**Pregnancy**  
The studies carried out on animals do not show any teratogenic effect. Due to the absence of teratogenic effect on animals, a malformative effect on the human kind is not expected. Indeed, until today, the substances responsible of malformations on the human kind have been teratogenic on animals during studies carried out on two species.

Clinically, the analysis of a high number of pregnancies has obviously shown no particular malformative or fœtotoxic effect of the lidocaine. However, only epidemiological studies would allow verifying the absence of risk. Consequently, the use of lidocaine can be prescribed for odonto-stomatology indications during pregnancy, only if necessary.

**Breastfeeding**

Like other local anaesthetics, lidocaine diffuses into breast milk in very small quantities; however, breastfeeding can be continued following the anaesthetic procedure.

**4.7 Effects on ability to drive and use machines**

XYLOROLLAND AVEC ADRENALINE has a moderate influence on the ability to drive and use machines.

**4.8 Side effects**

Like with all the anaesthetics used in odonto-stomatology, lipothymias can happen.

This product contains sodium metabisulphite, which can induce or accentuate anaphylactic reactions.

In the case of overdose or in certain predisposed patients, the following clinical signs may be observed:

- on the central nervous system: nervousness, agitation, yawning, tremor, apprehension, nystagmus, logorrhoea, headache, nausea, ringing in the ears. In the presence of these warning signs, the patient must be asked to hyperventilate, and attentive surveillance is required to prevent possible deterioration with seizures followed by CNS depression.
- on the respiratory system: tachypnoea, then bradypnoea, possibly leading to apnoea.
- on the cardiovascular system: tachycardia, bradycardia, cardiovascular depression with arterial hypotension, possibly leading to collapse, arrhythmias (premature ventricular complexes, ventricular fibrillation), disorders of conduction (atrioventricular block).

These cardiac manifestations can lead to cardiac arrest.

**Reporting of suspected side effects**

The reporting of suspected side effects after approval of the medicinal product is important. It allows continuous monitoring of the benefit/risk ratio of the medicinal product. Health professionals declare any suspected side effects through the national reporting system.

**4.9 Overdose**

Toxic reactions, reflecting overdose of local anaesthetic, can occur in two situations: either immediately, due to relative overdose resulting from accidental intravenous injection, or more delayed, corresponding to true overdose due to the use of an excessive quantity of anaesthetic.

**Action in case of overdose**

As soon as warning signs are observed, ask the patient to hyperventilate, place the patient in the supine position, when necessary. In the case of clonic seizures, oxygenation injection of a benzodiazepine. Treatment may require intubation with assisted ventilation.

**5- PHARMACOLOGICAL PROPERTIES****5.1 Pharmacodynamic properties**

Pharmacotherapeutic class: **LOCAL ANAESTHETICS**,  
ATC Code: **N01BB52**

**Mechanism of action**

Lidocaine hydrochloride is an amino-amide local anaesthetic, which blocks propagation of the nerve impulse along the nerve fibre at the site of injection.

The addition of adrenaline to the lidocaine solution delays the passage of the lidocaine into the systemic circulation and maintains a prolonged active tissue concentration, allowing obtaining a less haemorrhagic operative field. Anaesthesia is obtained within 2 to 3 minutes. The duration of anaesthesia allowing the surgical procedure is about 90 to 120 minutes and 5 to 10 minutes on the pulp.

**5.2 Pharmacokinetic properties Distribution**

When injected into the oral mucosa, lidocaine reaches a peak blood concentration about 10 to 15 minutes after injection.

**Elimination**

The mean elimination half-life of lidocaine hydrochloride is about 90 minutes.

Lidocaine hydrochloride is mainly metabolised in the liver; 5 to 10% of the dose are eliminated under unchanged form in the urine.

**5.3 Preclinical safety data**

Studies carried out on animals have demonstrated the good tolerance of lidocaine. Like other amide local anaesthetics, high doses of the active substance can induce toxic reactions on the central nervous system and/or on the cardiovascular system (see section 4.8).

**6- PHARMACEUTICAL DATA****6.1 List of excipients**

Sodium chloride, sodium metabisulphite, hydrochloric acid, sodium hydroxide, water for injections.

**6.2 Incompatibilities**

In the absence of compatibility studies, this medicinal product should not be mixed with other medicinal products.

**6.3 Shelf life**

Before opening: 2 years.

After opening: the product must be used immediately.

**6.4 Special storage precautions**

Store at a temperature below + 25°C and away from light.

**6.5 Nature and content of external packing**

1.8ml in cartridge (type I colourless glass) with a stopper (bromobutyl) and capsule (aluminium) with joint (bromobutyl). Box of 50.

**6.6 Special precautions for disposal and handling**

Like for all cartridges, the diaphragm will be disinfected just before use. It will be carefully plugged:

- either with ethyl alcohol at 70%,
  - or with pure isopropyl alcohol at 90% for pharmaceutical use.
- The cartridges must never be plunged in any solution.

Do not mix the injectable solution with other products in the same syringe.

Any opened cartridge of anaesthetic solution must not be re-used.

**7- HOLDER OF THE MARKETING AUTHORIZATION**

PRODUITS DENTAIRES PIERRE ROLLAND

ZI du Phare - 17 avenue Gustave Eiffel - 33700 MERIGNAC

**8- FRENCH REGISTRATION ID NUMBER**

CIP 34009 500 211 0 5 or 500 211-0:

1.8ml in cartridge (glass) with a stopper (bromobutyl); box of 50.

**9- DATE OF FIRST AUTHORIZATION/OF RENEWAL OF THE AUTHORIZATION IN FRANCE**

Date of first authorization:

15<sup>th</sup> October 1997

Date of last renewal:

15<sup>th</sup> October 2007

**10- DATE OF TEXT UP-DATING IN FRANCE**

13 March 2019

**CONDITIONS OF PRESCRIPTION AND DELIVERY IN FRANCE**

List I.

Medicinal product reserved for professional use according to article R.5121-80 of the French public health code.

# INFOS & CONTACTS

Quality Commitment for  
Greater Clinical Experience

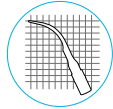

**Perfectly controlled vibrations**  
Precise treatment



**Automatic power regulation**  
Constant efficacy



**Perfect adaptation of the screw thread**  
Maximal power transmission



**Specific harness of steel nearest to enamel**  
Preserved teeth



**Increased tactile sense**  
Clinical comfort improved

CHOOSE



ACTEON® has always designed tips that respect the tooth's anatomy and vibrate in perfect harmony with the handpiece.

The potential imperfections in compatibility of brand x tips, both physical and electronic, may cause risks and premature wear of equipment.

**Risks for the patient**

- Risk of damaging patient's tissues (enamel, cement, etc.).
- Risk of breaking the tip, possibly with the broken piece being swallowed or inhaled by the patient, or lost in the tissues.

**Risk for the equipment**

Risk of handpiece heating (meaning a loss in electromechanical output), which could lead to handpiece damage.

**Loss of efficiency**

Tip wear alters its efficiency (-2mm = -50% efficiency), reduces its roughness, vibration and movement.

Understandably, ACTEON® liability - both legal and with regard to warranty of parts and accessories - cannot be engaged for damages that arise from the use of any other than genuine accessories.

*You always come back to ACTEON® tips.*

# INFOS & CONTACTS

## Wear Guide

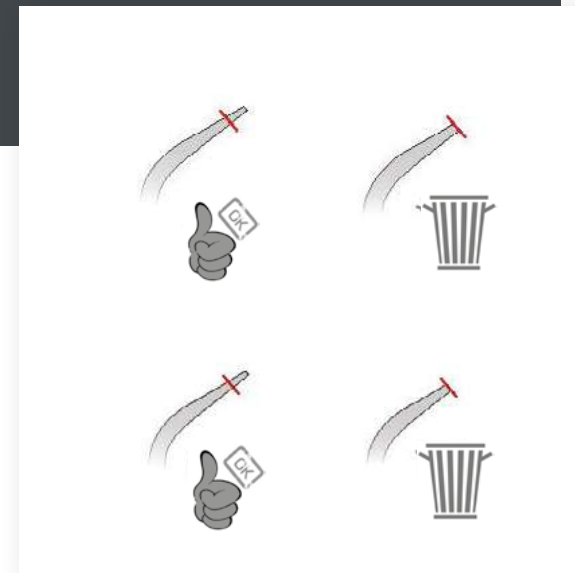

1



1S



2



3



10P



10X



10Z

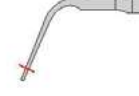

H3

H4R

H4L

H1

H2R

H2L



## WARRANTY POLICY

### ACTEON® ALIGNS ITS WARRANTY POLICY

All ACTEON® products will now be guaranteed for 2 years from the date of purchase, subject to proof of purchase (or without subject proof, 2 years from the date of purchase by the dealer).



Professional dental products.

The products in this catalog are mostly medical devices. Read carefully the instructions in the leaflet supplied with the product or available on the site: [www.acteongroup.com](http://www.acteongroup.com). Medical Devices marketed by SATELEC®, SOPRO® and Produits Dentaires Pierre Rolland® are not reimbursed by health insurance organizations.

Manufacturer (unless otherwise stated):

Imaging: SOPRO® - France except for X-Mind® range of products and WhiteFox: De Götzen - Italy

Equipment: SATELEC® - France

Pharma: Produits Dentaires Pierre Rolland SAS - France

Revision date: September 2020

Non contractual document - Ref. D00813 - 2020 - Copyright © 2020 ACTEON®  
All rights reserved. No information or part of this document may be reproduced or transmitted in any form without the prior permission of ACTEON.  
The information in this document may be modified by ACTEON® without notice.